

**CITY OF VINELAND
VINELAND, NEW JERSEY**

SPECIFICATIONS

FOR

**ELECTRIC UTILITY DISTRIBUTION
DISTRIBUTION TRANSFORMERS**

COV BID # 2025-40

BID OPENING: WEDNESDAY, DECEMBER 3, 2025
PREVAILING TIME: 2:00 P.M.

**PURCHASING DIVISION
640 E WOOD STREET
P.O. BOX 1508
VINELAND, NJ 08362-1508**

**Miguel A. Mercado, QPA
Purchasing Agent
(856) 794-4040 Phone
(856) 405-4605 Facsimile
mmercado@vinelandcity.org**



CITY OF
VINELAND
WHERE IT'S ALWAYS GROWING SEASON

640 E. WOOD STREET
P.O. BOX 1508
VINELAND, NJ 08362-1508

DEPARTMENT OF FINANCE
DIVISION OF PURCHASING
MIGUEL MERCADO, QPA
PURCHASING AGENT

PHONE: (856) 794-4040
FAX: (856) 405-4605

NOTICE TO BIDDERS

Sealed bids will be received by the Purchasing Agent of the City of Vineland on Wednesday, December 3, 2025 at 2:00 p.m. prevailing time in the Purchasing Office, 5th Floor, 640 E. Wood Street, Vineland, New Jersey 08360, at which time and place bids will be opened and read in public for the furnishing of:

COV BID # 2025-40 ELECTRIC UTILITY DISTRIBUTION-DISTRIBUTION TRANSFORMERS

Bid must be submitted in **duplicate** and shall be enclosed in an opaque sealed envelope, addressed to "Division of Purchasing, City of Vineland, 640 E. Wood Street, PO Box 1508, Vineland, NJ 08362-1508"

Bidders shall comply with the requirements of N.J.S.A. 10:5-31 and N.J.A.C. 17-27 et seq.

You must submit paper documents as your bid package. We cannot accept electronic copies. The documents to be submitted start with the Check List. **(PLEASE DO NOT SUBMIT THE SPECIFICATIONS WITH YOUR BID PACKAGE.)** **Original signatures must be on one document.** (Please use **blue** ink for the signatures.) The duplicate can be a photocopy.

If you have any questions, please contact the Purchasing Agent at the above number or email: PurchasingOffice@vinelandcity.org

DO NOT STAPLE DOCUMENTS
DO NOT DOUBLE SIDE

**CITY OF VINELAND
GENERAL INSTRUCTIONS**

I. SUBMISSION OF BIDS

- A. Sealed bids shall be received in accordance with public advertisement as required by law, with a copy of said notice being attached hereto and made a part of these specifications.
- B. Each bid shall be submitted on the proposal form attached and shall be submitted in a clearly marked sealed envelope addressed to:

If delivered:

**DIVISION OF PURCHASING
640 E. WOOD STREET
5TH FLOOR
VINELAND NJ 08360**

If mailed:

**DIVISION OF PURCHASING
640 E. WOOD STREET 5TH FL
PO BOX 1508
VINELAND NJ 08362-1508**

* Do not use PO Box on Overnight Delivery Services, i.e. (Fed-Ex)

Bidder's name, address, bid category, and due date must appear on the outside of the BID ENVELOPE containing the bid.

- C. Sealed bids will be received by the Purchasing Agent or designated representative, at the time and location as stated in the Notice to Bidders, and at such time and place will be publicly opened and read aloud.
- D. It is the bidder's responsibility to see that bids are presented to the Purchasing Agent on the hour **and at the place designated**. Bids may be hand delivered or mailed; however, the City disclaims any responsibility for bids forwarded by regular or express mail. If the bid is sent by express mail service, the designation in sub-section B, above, must also appear on the outside of the express mail envelope. Bids received after the designated time and date will be returned unopened. The City of Vineland shall not be responsible for late postal or overnight delivery, nor shall postmark dates or overnight dates be considered in honoring of bids. The City of Vineland shall not be responsible for bidder's hand delivering bids who arrive late or to the wrong location.
- E. Sealed bids forwarded to the City before the time of opening of bids may be withdrawn upon written application of the bidder who shall be required to produce evidence showing that the individual is or represents the principal or principals involved in the bid. Once bids have been opened, they shall remain firm for a period of sixty (60) calendar days.
- F. All prices and amounts must be written in ink or preferably machine-printed. Bids containing any conditions, omissions, unexplained erasures or alterations, items not called for in the bid proposal form, attachment of additive information not required by the specifications, or irregularities of any kind, may be rejected by the City. Any changes, whiteouts, strikeouts, etc. in the bid must be initialed in ink by the person signing the bid.
- G. Bids will be received only on the bidding forms attached to this specification or a true copy thereof with all notations to be done in ink or typed and signatures must be done in ink. **ONLY ORIGINAL**

SIGNATURES ON ALL DOCUMENTS WILL BE ACCEPTED. RUBBER STAMPS, COMPUTER GENERATED SIGNATURES, COPIER GENERATED SIGNATURES, OR ANY OTHER ARTIFICIAL SIGNATURES SHALL NOT BE ACCEPTABLE AND SHALL BE REASON FOR REJECTION. City of Vineland will not be held responsible for any erroneous pages or pages missing from this bid document if it is obtained from a source other than the Purchasing Department of the City of Vineland. City of Vineland will not be held responsible if bidders (vendors) fail to receive any updates or addenda to the specification, if they haven't contacted the Purchasing Department.

- H. Each bid proposal form must give the full business address, business phone, fax, the contact person of the bidder, and be signed by an authorized representative as follows:
- Bids by partnerships must furnish the full name of all partners and must be signed in the partnership name by one of the members of the partnership or by an authorized representative, followed by the signature and designation of the person signing.
 - Bids by corporations must be signed in the legal name of the corporation, followed by the name of the State in which incorporated and must contain the signature and designation of the president, secretary or other person authorized to bind the corporation in the matter.
 - Bids by sole-proprietorship shall be signed by the proprietor.
 - When requested, satisfactory evidence of the authority of the officer signing shall be furnished.
- I. Bidder should be aware of the following statutes that represent "Truth in Contracting" laws:
- N.J.S.A. 2C:21-34, et seq. governs false claims and representations by bidders. It is a serious crime for the bidder to knowingly submit a false claim and/or knowingly make material misrepresentation.
 - N.J.S.A. 2C:27-10 provides that a person commits a crime if said person offers a benefit to a public servant for an official act performed or to be performed by a public servant, which is a violation of official duty.
 - N.J.S.A. 2C:27-11 provides that a bidder commits a crime if said person, directly or indirectly, confers or agrees to confer any benefit not allowed by law to a public servant.
 - Bidder should consult the statutes or legal counsel for further information.
- J. Potential bidders are hereby cautioned that they are bidding at their own risk and that the specifications/bid packages may or may not be complete if the specifications/bid packages were provided by a third party supplier.
- The City shall not be responsible for third party supplied specifications/bid packages.
- K. The City reserves the right to reject individual and/or all bids in accordance with law.
- L. Any prospective bidder who wishes to challenge a bid specification shall file such challenge in writing with the Purchasing Agent no less than three (3) business days prior to the opening of the bids. Challenges filed after that time shall be considered void and having no impact on the contracting unit or the award of a contract; N.J.S.A. 40A: 11-13 (e).
- M. Contracts shall be awarded to the lowest responsive and responsible bidder. City Council reserves the right to reject any and all bids and to waive minor discrepancies therein. City Council also reserves the right to split bids, award individual items, or to award groups of items and categories of items.
- N. Questions concerning this bid shall be directed in writing to the Purchasing Department, Attention: Miguel Mercado, Purchasing Agent, either by facsimile at (856) 405-4605 or by email at PurchasingOffice@vinelandcity.org. Last day for questions is noon, Monday, November 17, 2025.

II. BID SECURITY AND BONDING REQUIREMENTS

The following provisions if indicated by an (X), shall be applicable to this bid and be made a part of the bid documents:

A. BID GUARANTEE

Bidder shall submit with the bid a certified check, cashier's check or a bid bond in the amount of ten percent (10%) of the total price bid, but not in excess of \$20,000, payable unconditionally to the City.

When submitting a Bid Bond, it shall contain Power of Attorney for full amount of Bid Bond from a surety company authorized to do business in the State of New Jersey and acceptable to the City.

The check or bond of the unsuccessful bidder(s) shall be returned pursuant to N.J.S.A. 40A:11-24a. The check or bond of the bidder to whom the contract is awarded shall be retained until a contract is executed and the required performance bond or other security is submitted.

The check or bond of the successful bidder shall be forfeited if the bidder fails to enter into a contract pursuant to N.J.S.A. 40A:11-21.

Failure to submit a bid guarantee shall result in rejection of the bid.

B. CONSENT OF SURETY

Bidder shall submit with the bid a Certificate (Consent of Surety) with Power of Attorney for full amount of bid price from a Surety Company authorized to do business in the State of New Jersey and acceptable to the City stating that it will provide said bidder with a Performance Bond in the full amount of the bid. This certificate shall be obtained in order to confirm that the bidder to whom the contract is awarded will furnish Performance and Payment Bonds from an acceptable surety company on behalf of said bidder, any or all subcontractors or by each respective subcontractor or by any combination thereof which results in performance security equal to the total amount of the contract, pursuant to N.J.S.A. 40A:11-22.

Failure to submit a consent of surety shall result in rejection of the bid.

C. PERFORMANCE BOND

Successful bidder shall simultaneously with the delivery of the executed contract, submit an executed bond in the amount of one hundred percent (100%) of the acceptable bid as security for the faithful performance of this contract.

The performance bond provided shall not be released until final acceptance of the whole work and then only if any liens or claims have been satisfied. The surety on such bond or bonds shall be a duly authorized surety company authorized to do business in the State of New Jersey pursuant to N.J.S.A. 17:31-5.

Failure to submit this with the executed contract shall be cause for declaring the contract null and void pursuant to N.J.S.A. 40A:11-22.

D. LABOR AND MATERIAL (PAYMENT) BOND

Bidder shall with the delivery of the performance bond submit an executed payment bond to guarantee payment to laborers and suppliers for the labor and material used in the work performed under the contract.

Failure to submit a labor and material bond with the performance bond shall be cause for declaring the contract null and void.

E. MAINTENANCE BOND

Upon acceptance of the work by the City, the contractor shall submit a maintenance bond (N.J.S.A. 40A:11-16.3) in an amount not to exceed **100%** of the project costs guaranteeing against defective quality of work or materials for the period of:

_____ 1 year
_____ 2 years

III. INTERPRETATION AND ADDENDA

- A. The bidder understands and agrees that its bid is submitted on the basis of the specifications prepared by the City. The bidder accepts the obligation to become familiar with these specifications.
- B. Bidders are expected to examine the specifications and related bid documents with care and observe all their requirements. Ambiguities, errors or omissions noted by bidders should be promptly reported in writing to the Purchasing Agent. Any prospective bidder who wishes to challenge a bid specification shall file such challenges in writing with the contracting agent no less than three business days prior to the opening of the bids. Challenges filed after that time shall be considered void and having no impact on the contracting unit or the award of a contract pursuant to N.J.S.A. 40A:11-13. In the event the bidder fails to notify the City of such ambiguities, errors or omissions, the bidder shall be bound by the requirements of the specifications and the bidder's submitted bid.
- C. No oral interpretation and or clarification of the meaning of the specifications for any goods and services will be made to any bidder. Such request shall be in writing, addressed to the Purchasing Agent. In order to be given consideration, a written request must be received at least ten (10) business days prior to the date fixed for the opening of the bid for goods and services.

All interpretations, clarifications and any supplemental instructions will be in the form of written addenda to the specifications, and will be distributed to all prospective bidders. All addenda so issued shall become part of the specification and bid documents, and shall be acknowledged by the bidder in the bid. The City's interpretations or corrections thereof shall be final.

When issuing addenda, the City shall provide required notice prior to the official receipt of bids to any person who has submitted a bid or who has received a bid package pursuant to N.J.S.A. 40A:11-23c.1.

D. Discrepancies in Bids

- 1. Ditto marks are not considered writing or printing and shall not be used.
- 2. In the event that there is a discrepancy between the unit prices and the extended totals, the unit prices shall prevail. In the event there is an error of the summation of the extended totals, the computation by the City of the extended totals shall govern.

E. Pre-Bid Conference

If stated in the Notice to Bidders:

A Pre-Bid Conference is not required for this bid.

A pre-bid conference for this proposal will be held on _____.
Attendance is not mandatory, but is strongly recommended. Failure to attend does not relieve the bidder of any obligations or requirements.

IV. BRAND NAMES, STANDARDS OF QUALITY AND PERFORMANCE

- A. Brand names and/or descriptions used in these specifications are to acquaint bidders with the types of goods and services desired and will be used as a standard by which goods and services offered as equivalent will be evaluated.
- B. Variations between the goods and services described and the goods and services offered are to be fully identified and described by the bidder on a separate sheet and submitted with the bid proposal form. Vendor literature WILL NOT suffice in explaining exceptions to these specifications. In the absence of any exceptions by the bidder, it will be presumed and required that the goods and services as described in the bid specification be provided or performed.
- C. It is the responsibility of the bidder to document and/or demonstrate the equivalency of the goods and services offered. The City reserves the right to evaluate the equivalency of the goods and services.
- D. In submitting its bid, the bidder certifies that the goods and services to be furnished will not infringe upon any valid patent or trademark and that the successful bidder shall, at its own expense, defend any and all actions or suits charging such infringement, and will save the City harmless from any damages resulting from such infringement.
- E. Only manufactured and farm products of the United States, wherever available, shall be used pursuant to N.J.S.A. 40A:11-18.
- F. The contractor shall guarantee any or all goods and services supplied under these specifications. Defective or inferior goods shall be replaced at the expense of the contractor. The contractor will be responsible for return freight or restocking charges.

V. INSURANCE AND INDEMNIFICATION

The insurance documents as listed below shall include but are not limited to the following coverage's. (where insurance requirements are listed under other sections of these specifications, the higher limits will prevail.)

A. INSURANCE REQUIREMENTS

1. Worker's Compensation Insurance

Workers Compensation insurance shall be maintained in full force during the life of the contract, covering all employees engaged in performance of the contract pursuant to N.J.S.A. 34:15-12(a) and N.J.A.C. 12:235-1.6. Statutory Limit for Workers' Compensation and \$500,000 for Employer's Liability.

2. General Liability Insurance

General liability insurance shall be provided with limits of not less than \$1,000,000 any one person/any one accident for bodily injury and property damage and \$3,000,000 aggregate, and shall be maintained in full force during the life of the contract.

3. Automobile Liability Insurance

Automobile liability insurance covering contractor for claims arising from owned, hired and non-owned vehicles with limits of not less than \$1,000,000 any one person / any one accident for bodily injury and property damage, and shall be maintained in full force during the life of the contract.

4. Other Forms of Insurance Required

B. CERTIFICATES OF THE REQUIRED INSURANCE

Certificates of Insurance for those policies required above shall be submitted with the contract. Such coverage shall be with an insurance company authorized to do business in the State of New Jersey and shall name the City of Vineland as an additional insured.

Self-insured contractors shall submit an affidavit attesting to their self-insured coverage and shall name the City of Vineland as an additional insured.

C. INDEMNIFICATION

Bidder shall indemnify and hold harmless the City of Vineland from all claims, suits or actions, and damages or costs of every name and description to which the City of Vineland may be subjected or put by reason of injury to the person or property of another, or the property of the City of Vineland resulting from negligent acts or omissions on the part of the contractor, the contractor's agents, servants or subcontractors in the delivery of goods and services, or in the performance of the work under the contract.

VI. PRICING INFORMATION FOR PREPARATION OF BIDS

- A. The City of Vineland is exempt from any local, state or federal sales, use or excise tax.
- B. Estimated Quantities (Open-End Contracts): The City has attempted to identify the item(s) and the estimated amounts of each item bid to cover its requirements; however, past experience shows that the amount ordered may be different than that submitted for bidding. The right is reserved to decrease or increase the quantities specified in the specifications pursuant to N.J.A.C. 5:30-11.2 and 11.10. **NO MINIMUM PURCHASE IS IMPLIED OR GUARANTEED.**
- C. Contractor shall be responsible for obtaining any applicable permits or licenses from any government entity that has jurisdiction to require the same. All bids submitted shall have included this cost.
- D. Bidders shall insert prices for furnishing goods and services required by these specifications. Prices shall be net, including any charges for packing, crating, containers, etc. All transportation charges shall be fully prepaid by the contractor, F.O.B. destination and placement at locations specified by the City. As specified, placement may require inside deliveries. No additional charges will be allowed for any transportation costs resulting from partial shipments made for the contractor's convenience.
- E. No bidder will be allowed to offer more than one price on each item even though he/she may feel that he has two (2) or more types/products that will meet the specifications. Bidders must determine for themselves which type/product to offer. If said bidder should submit more than one price on any item, all prices for the item shall be rejected.
- F. **The contract period will be from January 1, 2026 expiring on December 31, 2026 with the option to renew for one (1) additional year ending December 31, 2027. The option year is not an automatic renewal. This must be approved by all parties and by resolution of the governing body.**

VII. STATUTORY AND OTHER REQUIREMENTS

The following are mandatory requirements of this bid and contract.

A. MANDATORY AFFIRMATIVE ACTION CERTIFICATION

No firm may be issued a contract unless it complies with the affirmative action provisions of N.J.S.A. 10:5-31 et seq. and N.J.A.C. 17:27-1 et seq. The following information summarizes the full, required regulatory text, which is included as Exhibit A of this bid specification.

1. Goods and Services (including professional services) Contracts

Each contractor shall submit to the public agency, after notification of award but prior to execution of a goods and services contract, one of the following three documents:

- i. A photocopy of a valid letter that the contractor is operating under an existing Federally approved or sanctioned affirmative action program (good for one year from the date of the letter); or
- ii. A photocopy of a Certificate of Employee Information Report approval, issued in accordance with N.J.A.C. 17:27-4; or
- iii. A photocopy of an Employee Information Report (Form AA 302) provided by the Division and distributed to the public agency to be completed by the contractor in accordance with N.J.A.C. 17:27-4.

2. Maintenance/Construction Contracts

After notification of award, but prior to signing the contract, the contractor shall submit to the public agency compliance officer and the Division of Contract Compliance and Equal Employment Opportunity in Public Contracts (Division) an initial project workforce report (Form AA201) provided to the public agency by the Division for distribution to and completion by the contractor, in accordance with N.J.A.C. 17:27-7.

The contractor shall also submit a copy of the Monthly Project Workforce Report once a month thereafter for the duration of the contract to the Division and to the public agency compliance officer. The contractor shall also cooperate with the public agency in the payment of budgeted funds, as is necessary, for on-the job and/or off-the-job programs for outreach and training of minorities and women.

B. AMERICANS WITH DISABILITIES ACT OF 1990

Discrimination on the basis of disability in contracting for the purchase of goods and services is prohibited. Bidders are required to read Americans with Disabilities language that is included as Appendix A of this specification and agree that the provisions of Title II of the Act are made a part of the contract. The contractor is obligated to comply with the Act and to hold the City harmless.

C. STOCKHOLDER DISCLOSURE

N.J.S.A. 52:25-24.2 provides that no corporation, partnership, limited partnership, limited liability corporation, limited liability partnership, Subchapter S corporation or sole proprietorship, shall be awarded any contract for the performance of any work or the furnishing of any goods and services, unless, prior to the receipt of the bid or accompanying the bid of said corporation, partnership, limited partnership, limited liability corporation, limited liability partnership, Subchapter S corporation or sole proprietorship, bidders shall submit a statement setting forth the names and addresses of all stockholders in the corporation or partnership who own (10%) ten percent or more of its stock of any class, or of all individual partners in the

partnership who own a ten percent or greater interest therein. The included Statement of ownership shall be completed and attached to the bid proposal. This requirement applies to all forms of corporations and partnerships, including, but not limited to, limited partnerships, limited liability corporations, limited liability partnerships and Subchapter S corporations. Failure to submit a stockholder disclosure document shall result in rejection of the bid.

D. PROOF OF BUSINESS REGISTRATION

N.J.S.A. 52:32-44 requires that each bidder (contractor) submit proof of business registration. Certificate must be submitted prior to award of the contract and the bidder had to have obtained the BRC prior to receipt of bids. A BRC is obtained from the New Jersey Division of Revenue. Information on obtaining a BRC is available on the internet at www.nj.gov/njbgs or by phone at (609) 292-1730. N.J.S.A. 52:32-44 imposes the following requirements on contractors and all subcontractors that **knowingly** provide goods or perform services for a contractor fulfilling this contract:

- 1) The contractor shall provide written notice to its subcontractors and suppliers to submit proof of business registration to the contractor;
- 2) Prior to receipt of final payment from a contracting agency, a contractor must submit to the contacting agency an accurate list of all subcontractors or attest that none was used;
- 3) During the term of this contract, the contractor and its affiliates shall collect and remit, and shall notify all subcontractors and their affiliates that they must collect and remit to the Director, New Jersey Division of Taxation, the use tax due pursuant to the Sales and Use Tax Act, (N.J.S.A. 54:32B-1 et seq.) on all sales of tangible personal property delivered into this State.

A contractor, subcontractor or supplier who fails to provide proof of business registration or provides false business registration information shall be liable to a penalty of \$25 for each day of violation, not to exceed \$50,000 for each business registration not properly provided or maintained under a contract with a contracting agency. Information on the law and its requirements is available by calling (609) 292-1730.

If boxes of the following items are checked, they are mandatory requirements of the bid proposal and contract.

E. NEW JERSEY WORKER AND COMMUNITY RIGHT TO KNOW ACT

The manufacturer or supplier of chemical substances or mixtures shall label them in accordance with the N.J. Worker and Community Right to Know Law (N.J.S.A. 34:5A-1 et seq., and N.J.A.C 8:59-2 et seq.). Containers that the law and rules require to be labeled shall show the Chemical Abstracts Service number of all the components and the chemical name. Further, all applicable Material Safety Data Sheets (MSDS) - hazardous substance fact sheet - must be furnished.

F. PREVAILING WAGE ACT

Pursuant to N.J.S.A. 34:11-56.25 et seq., contractors on projects for public work shall adhere to all requirements of the New Jersey Prevailing Wage Act. The contractor shall be required to submit a certified payroll record to the City within ten (10) days of the payment of the wages. The contractor is also responsible for obtaining and submitting all subcontractors' certified payroll records within the aforementioned time period. The contractor shall submit said certified payrolls in the form set forth in N.J.A.C. 12:60-6.1(c). It is the contractor's responsibility to obtain any additional copies of the certified payroll form to be submitted by contacting the New Jersey Department of Labor and Workforce Development, Division of Workplace Standards. Bidders are cautioned to take into consideration statutory legal requirements, particularly, the payment of prevailing wages. It is Bidder's sole responsibility for determining the correct labor classification(s) and paying the correct and proper wage and benefits and it is imperative that the Contractor familiarize itself with the current wage and benefit rates before submitting bids based on these specifications. **NOTE: Additional information and current wage rates are available at: http://lwd.state.nj.us/labor/wagehour/wagehour_index.html.**

G. THE PUBLIC WORKS CONTRACTOR REGISTRATION ACT

N.J.S.A. 34:11-56.48 et seq. requires that a general or prime contractor and any listed subcontractors named in the contractor's bid proposal shall possess a certificate *at the time the bid proposal is submitted*. After bid proposals are received and prior to award of contract, the successful contractor shall submit a copy of the contractor's certification along with those of all listed subcontractors. All non-listed subcontractors and lower tier sub-subcontractors shall be registered prior to starting work on the project. It is the general contractor's responsibility that all non-listed sub-contractors at any tier have their certificate prior to starting work on the job.

Under the law a "contractor" is "a person, partnership, association, joint stock company, trust, corporation or other legal business entity or successor thereof who enters into a contract" which is subject to the provisions of the New Jersey Prevailing Wage Act [N.J.S.A. 34:11-56.25, et seq.] It applies to contractors based in New Jersey or in another state.

The law defines "public works projects" as contracts for "public work" as defined in the Prevailing Wage statute [N.J.S.A. 34:11-56.26(5)]. The term means:

- "Construction, reconstruction, demolition, alteration, or repair work, or maintenance work, including painting and decorating, done under contract and paid for in whole or in part out of the funds of a public body, except work performed under a rehabilitation program.
- "Public work" shall also mean construction, reconstruction, demolition, alteration, or repair work, done on any property or premises, whether or not the work is paid for from public funds..."
- "Maintenance work" means the repair of existing facilities when the size, type or extent of such facilities is not thereby changed or increased. While "maintenance" includes painting and decorating and is covered under the law, it does not include work such as routine landscape maintenance or janitorial services.

To register, a contractor must provide the State Department of Labor with a full and accurately completed application form. The form is available online at http://lwd.state.nj.us/labor/wagehour/regperm/pw_cont_reg.html

N.J.S.A. 34:11-56.55 specifically prohibits accepting applications for registration as a substitute for a certificate of registration.

H. NON-COLLUSION AFFIDAVIT (**Not Applicable**)

The Affidavit shall be properly executed and submitted with the bid proposal.

I. PAY TO PLAY

Starting in January, 2007, business entities are advised of their responsibility to file an annual disclosure statement of political contributions with the New Jersey Election Law Enforcement Commission (ELEC) pursuant to N.J.S.A. 19:44A-20.27 if they receive contracts in excess of \$50,000 from public entities in a calendar year.

Business entities are responsible for determining if filing is necessary. Additional information on this requirement is available from ELEC at 888-313-3532 or at www.elec.state.nj.us.

J. NJ ONE CALL

By presenting a bid, contractor declares that he is aware of and, if required, will comply with the requirements of the "Underground Facility Protection Act (Public Law 1994, Chapter 118)" prior to commencing any intended excavation. The telephone number to call is 1-800-272-1000. The successful bidder will be required to show compliance with the requirement by submitting to the appropriate project coordinator the confirmation number obtained from ONE-CALL before any excavation is undertaken.

VIII. METHOD OF CONTRACT AWARD

- A. The length of the contract shall be stated in the technical specifications. Pursuant to requirements of N.J.A.C. 5:30-5.1 et seq., any contract resulting from this bid shall be subject to the availability and appropriation of sufficient funds annually. Please see Section X, Termination of Contract, Sub-section E, for additional information.
- B. If the award is to be made on the basis of a base bid only, it shall be made to that responsible bidder submitting the lowest base bid.
- C. If the award is to be made on the basis of a combination of a base bid with selected options, it shall be made to that responsible bidder submitting the lowest net bid.
- D. The City may also elect to award the contract on the basis of unit prices.
- E. The form of contract shall be submitted by the City to the successful bidder. Terms of the specifications/bid package prevail. Bidder exceptions must be formally accepted by the City.
- G. **Choice of Law:** The agreement with the successful bidder shall be construed in accordance with the laws of the State of New Jersey. In the event of litigation or other legal proceedings commenced to enforce the terms of the agreement, the venue of such litigation shall be the Superior Court of New Jersey, Cumberland County.

IX. CAUSES FOR REJECTING BIDS

Bids may be rejected for any of the following reasons:

- A. All bids pursuant to N.J.S.A. 40A:11-13.2;
- B. If more than one bid is received from an individual, firm or partnership, corporation or association under the same name;
- C. Multiple bids from an agent representing competing bidders;
- D. The bid is inappropriately unbalanced;
- E. The bidder is determined to possess, pursuant to N.J.S.A. 40A:11-4b, Prior Negative Experience; or,
- F. If the successful bidder fails to enter into a contract within 21 days, Sundays and holidays excepted, or as otherwise agreed upon by the parties to the contract. In this case at its option, the City may accept the bid of the next lowest responsible bidder. (N.J.S.A. 40A:11-24b)

X. TERMINATION OF CONTRACT

- A. If, through any cause, the contractor shall fail to fulfill in a timely and proper manner obligations under the contract or if the contractor shall violate any of the requirements of the contract, the City shall there upon have the right to terminate the contract by giving written notice to the contractor of such termination and specifying the effective date of termination. Such termination shall relieve the City of any obligation for balances to the contractor of any sum or sums set forth in the contract. City will pay only for goods and services accepted prior to termination.
- B. Notwithstanding the above, the contractor shall not be relieved of liability to the City for damages sustained by the City by virtue of any breach of the contract by the contractor and the City may withhold any payments to the contractor for the purpose of compensation until such time as the exact amount of the damage due the City from the contractor is determined.
- C. The contractor agrees to indemnify and hold the City harmless from any liability to subcontractors/suppliers concerning payment for work performed or goods supplied arising out of the lawful termination of the contract by the City under this provision.
- D. In case of default by the contractor, the City may procure the goods or services from other sources and hold the contractor responsible for any excess cost.
- E. Continuation of the terms of the contract beyond the fiscal year is contingent on availability of funds in the following year's budget. In the event of unavailability of such funds, the City reserves the right to cancel the contract.
- F. ACQUISITION, MERGER, SALE AND/OR TRANSFER OF BUSINESS, ETC.

It is understood by all parties that if, during the life of the contract, the contractor disposes of his/her business concern by acquisition, merger, sale and or/transfer or by any means convey his/her interest(s) to another party, all obligations are transferred to that new party. In this event, the new City(s) will be required to submit all documentation/legal instruments that were required in the original bid/contract. Any change shall be approved by the City.

- G. The contractor will not assign any interest in the contract and shall not transfer any interest in the same without the prior written consent of the City.
- H. The City may terminate the contract for convenience by providing 60 calendar days advanced notice to the contractor.

XI. PAYMENT

- A. No payment will be made unless duly authorized by the City's authorized representative and accompanied by proper documentation.
- B. Payment will be made in accordance with the City's policy and procedures.

XII. W-9

- A. Bidder shall complete W-9 form and submit to the City of Vineland Purchasing Department prior to contract award. This form is available at the following link:
<http://www.irs.gov/pub/irs-pdf/fw9.pdf?portlet=3>

XIII. Contract Records

As per N.J.A.C. 17:44-2.2 Vendor shall maintain all documentation related to products, transactions or services under this contract for a period of five years from the date of final payment. Such records shall be made available to the New Jersey Office of the State Comptroller upon request.

ATTACHMENT A – EXHIBIT A
MANDATORY EQUAL EMPLOYMENT OPPORTUNITY LANGUAGE
N.J.S.A. 10:5-31 et seq. (P.L.1975, c.127) and N.J.A.C. 17:27 et seq.

GOODS, GENERAL SERVICES, AND PROFESSIONAL SERVICES CONTRACTS

During the performance of this contract, the contractor agrees as follows:

The contractor or subcontractor, where applicable, will not discriminate against any employee or applicant for employment because of age, race, creed, color, national origin, ancestry, marital status, affectional or sexual orientation, gender identity or expression, disability, nationality or sex. Except with respect to affectional or sexual orientation and gender identity or expression, the contractor will ensure that equal employment opportunity is afforded to such applicants in recruitment and employment, and that employees are treated during employment, without regard to their age, race, creed, color, national origin, ancestry, marital status, affectional or sexual orientation, gender identity or expression, disability, nationality or sex. Such equal employment opportunity shall include, but not be limited to the following: employment, upgrading, demotion, or transfer; recruitment or recruitment advertising; layoff or termination; rates of pay or other forms of compensation; and selection for training, including apprenticeship. The contractor agrees to post in conspicuous places, available to employees and applicants for employment, notices to be provided by the Public Agency Compliance Officer setting forth provisions of this nondiscrimination clause.

The contractor or subcontractor, where applicable will, in all solicitations or advertisements for employees placed by or on behalf of the contractor, state that all qualified applicants will receive consideration for employment without regard to age, race, creed, color, national origin, ancestry, marital status, affectional or sexual orientation, gender identity or expression, disability, nationality or sex.

The contractor or subcontractor will send to each labor union, with which it has a collective bargaining agreement, a notice, to be provided by the agency contracting officer, advising the labor union of the contractor's commitments under this chapter and shall post copies of the notice in conspicuous places available to employees and applicants for employment.

The contractor or subcontractor, where applicable, agrees to comply with any regulations promulgated by the Treasurer pursuant to N.J.S.A.10:5-31 et seq., as amended and supplemented from time to time and the Americans with Disabilities Act.

The contractor or subcontractor agrees to make good faith efforts to meet targeted county employment goals established in accordance with N.J.A.C. 17:27-5.2.

The contractor or subcontractor agrees to inform in writing its appropriate recruitment agencies including, but not limited to, employment agencies, placement bureaus, colleges, universities, and labor unions, that it does not discriminate on the basis of age, race, creed, color, national origin, ancestry, marital status, affectional or sexual orientation, gender identity or expression, disability, nationality or sex, and that it will discontinue the use of any recruitment agency which engages in direct or indirect discriminatory practices.

The contractor or subcontractor agrees to revise any of its testing procedures, if necessary, to assure that all personnel testing conforms with the principles of job related testing, as established by the statutes and court decisions of the State of New Jersey and as established by applicable Federal law and applicable Federal court decisions.

In conforming with the targeted employment goals, the contractor or subcontractor agrees to review all procedures relating to transfer, upgrading, downgrading and layoff to ensure that all such actions are taken without regard to age, race, creed, color, national origin, ancestry, marital status, affectional or sexual orientation, gender identity or expression, disability, nationality or sex, consistent with the statutes and court decisions of the State of New Jersey, and applicable Federal law and applicable Federal court decisions.

The contractor shall submit to the public agency, after notification of award but prior to execution of a goods and services contract, one of the following three documents:

Letter of Federal Affirmative Action Plan Approval;

Certificate of Employee Information Report; or

Employee Information Report Form AA-302 (electronically provided by the Division and distributed to the public agency through the Division's website at: http://www.state.nj.us/treasury/contract_compliance).

The contractor and its subcontractors shall furnish such reports or other documents to the Division of Purchase & Property, CCAU, EEO Monitoring Program as may be requested by the office from time to time in order to carry out the purposes of these regulations, and public agencies shall furnish such information as may be requested by the Division of Purchase & Property, CCAU, EEO Monitoring Program for conducting a compliance investigation pursuant to N.J.A.C. 17:27-1.1 et seq.

**NEW JERSEY ANTI-DISCRIMINATION PROVISIONS
NJ.S.A.10:2-1 ET SEQ.**

Pursuant to NJ.S.A. 10:2-1, if awarded a contract, the contractor agrees that:

- a. In the hiring of persons for the performance of work under this contract or any subcontract hereunder, or for the procurement, manufacture, assembling or furnishing of any such materials, equipment, supplies or services to be acquired under this contract, no contractor, nor any person acting on behalf of such contractor or subcontractor, shall, by reason of race, creed, color, national origin, ancestry, marital status, gender identity or expression, affectional or sexual orientation or sex, discriminate against any person who is qualified and available to perform the work to which the employment relates;
- b. No contractor, subcontractor, nor any person on his behalf shall, in any manner, discriminate against or intimidate any employee engaged in the performance of work under this contract or any subcontract hereunder, or engaged in the procurement, manufacture, assembling or furnishing of any such materials, equipment, supplies or services to be acquired under such contract, on account of race, creed, color, national origin, ancestry, marital status, gender identity or expression, affectional or sexual orientation or sex;
- c. There may be deducted from the amount payable to the contractor by the contracting public agency, under this contract, a penalty of \$50.00 for each person for each calendar day during which such person is discriminated against or intimidated in violation of the provisions of the contract; and
- d. This contract may be canceled or terminated by the contracting public agency, and all money due or to become due hereunder may be forfeited, for any violation of this section of the contract occurring after notice to the contractor from the contracting public agency of any prior violation of this section of the contract.

(This space intentionally left blank)

AMERICANS WITH DISABILITIES ACT OF 1990
Equal Opportunity for Individuals with Disability

The contractor and the City of Vineland, (hereafter "City") do hereby agree that the provisions of title 11 of the Americans With Disabilities Act of 1990 (the "Act") (42 U.S.C. S121 01 et seq.), which prohibits discrimination on the basis of disability by public entities in all services, programs, and activities provided or made available by public entities, and the rules and regulations promulgated pursuant there unto, are made a part of this contract. In providing any aid, benefit, or service on behalf of the City of Vineland pursuant to this contract, the contractor agrees that the performance shall be in strict compliance with the Act. In the event that the contractor, its agents, servants, employees, or subcontractors violate or are alleged to have violated the Act during the performance of this contract, the contractor shall defend the City in any action or administrative proceeding commenced pursuant to this Act. The contractor shall indemnify, protect, and save harmless the City, its agents, servants, and employees from and against any and all suits, claims, losses, or damages, of whatever kind or nature arising out of or claimed to arise out of the alleged violation. The contractor shall, at its own expense, appear, defend, and pay any and all charges for legal services and any all costs and other expenses arising from such action or administrative proceeding or incurred in connection therewith. In any and all complaints brought pursuant to the City's grievance procedure, the contractor agrees to abide by any decision of the City which is rendered pursuant to said grievance procedure. If any action or administrative proceeding results in an award of damages against the City of Vineland or if the City of Vineland incurs any expense to cure a violation of the ADA which has been brought pursuant to its grievance procedure, the contractor shall satisfy and discharge the same at its own expense.

The City shall, as soon as practicable after a claim has been made against it, give written notice thereof to the contractor along with full and complete particulars of the claim. If any action or administrative proceedings is brought against the City of Vineland, or any of its agents, servants, and employees, the City shall expeditiously forward or have forwarded to the contractor every demand, complaint, notice, summons, pleading, or other process received by the City or its representatives.

It is expressly agreed and understood that any approval by the City of the services provided by the contractor pursuant to this contract will not relieve the contractor of the obligation to comply with the Act and to defend, indemnify, protect, and save harmless the City pursuant to this paragraph.

It is further agreed and understood that the City of Vineland assumes no obligation to indemnify or save harmless the contractor, its agents, servants, employees and servants, employees and subcontractors for any claim which may arise out of their performance of this Agreement. Furthermore, the contractor expressly understands and agrees that the provisions of this indemnification clause shall in no way limit the contractors obligations assumed in this Agreement, nor shall they be construed to relieve the contractor from any liability, nor preclude the City from taking any other actions available to it under any other provisions of the Agreement or otherwise at law.

City of Vineland

Revised Contract Language for BRC Compliance

Goods and Services Contracts (including Purchase Orders)

*Construction Contracts (including Public Works related Purchase Orders)

N.J.S.A. 52:32-44 imposes the following requirements on contractors and all subcontractors that knowingly provide goods or perform services for a contractor fulfilling this contract:

1. The contractor shall provide written notice to its subcontractors and suppliers to submit proof of business registration to the contractor;
2. Subcontractors through all tiers of a project must provide written notice to their subcontractors and suppliers to submit proof of business registration and subcontractors shall collect such proofs of business registration and maintain them on file;
3. Prior to receipt of final payment from a contracting agency, a contractor must submit to the contracting agency an accurate list of all subcontractors and suppliers or attest that none was used;
4. During the term of this contract, the contractor and its affiliates shall collect and remit and shall notify all subcontractors and their affiliates that they must collect and remit to the Director, New Jersey Division of Taxation, the use tax due pursuant to the Sales and Use Tax Act, (N.J.S.A. 54:32B-1 et seq.) on all sale of tangible personal property delivered into this State.

Pursuant to J.J.S.A. 54:49-4.1, a business organization that fails to provide a copy of a business registration as required, or that provides false business registration information, shall be liable for a penalty of \$25 for each day of violation, not to exceed \$50,000, for each proof of business registration not properly provided under a contract with a contracting agency. Information on the law and its requirements is available by calling (609) 292-9292.

NEW JERSEY BUSINESS REGISTRATION

Pursuant to P.L. 2004, c.57, all consultants (both in-state and out-of-state) must obtain a Business Registration Certificate (BRC) from the New Jersey Department of the Treasury, Division of Revenue prior to conducting business with the NJTPA. A consultant or sub-consultant who fails to submit a copy of a valid BRC in accordance with the statute will be held liable for monetary penalties in accordance with N.J.S.A. 54:49-4.1. Questions regarding how to obtain a BRC can be directed to the New Jersey Division of Revenue at (609) 292-1730. The business registration form (Form NJ-REG) can be found online at:

<http://www.state.nj.us/treasury/revenue/busregcert.shtml> or

<http://www.state.nj.us/treasury/revenue/gettingregistered.shtml>

Sample New Jersey Registration Certificates:

STATE OF NEW JERSEY BUSINESS REGISTRATION CERTIFICATE		<small>DEPARTMENT OF TREASURY/ DIVISION OF REVENUE PO BOX 252 TRENTON, N J 08646-0252</small>
TAXPAYER NAME:	TRADE NAME:	
TAXPAYER IDENTIFICATION#:	SEQUENCE NUMBER:	
ADDRESS:	ISSUANCE DATE:	
EFFECTIVE DATE:		
FORM-BRC(08-01)	<small>Acting Director</small>	<small>This Certificate is NOT assignable or transferable. It must be conspicuously displayed at above address.</small>

	STATE OF NEW JERSEY BUSINESS REGISTRATION CERTIFICATE
Taxpayer Name:	TAX REG TEST ACCOUNT
Trade Name:	
Address:	847 ROEBLING AVE TRENTON, NJ 08611
Certificate Number:	1093907
Date of Issuance:	October 14, 2004
For Office Use Only:	
	20041014112823533

Distribution Transformer Specification

Vineland Municipal Electric Utility

SECTION 337300

VMEU Project Code: 25-034

Revision 3

October 7, 2025

Project Lead: *William Burns*

Date: *10/07/2025*

Prepared by: *William Burns*

Date: *10/07/2025*

TABLE OF CONTENTS

PART 1 - GENERAL CONDITIONS 4

 1.1. Introduction 4

 1.2. City of Vineland – General Instructions 4

 1.3. Definitions of Terms..... 4

 1.4. Ownership..... 5

 1.5. Suspension 5

 1.6. Assigning 5

 1.7. Repairs and Replacements..... 5

 1.8. Codes and Standards..... 6

 1.9. Delivery 8

 1.10. Terms of Payment 8

 1.11. Bidder Requirements 8

 1.12. Transformer Data..... 9

 1.13. Proposals 9

 1.14. Releases 10

 1.15. Pricing Terms and Conditions 11

 1.16. Evaluation of Bids..... 12

 1.17. Exception to Bids..... 12

 1.18. Contract Period 13

 1.19. Estimated Quantities 13

PART 2 - GENERAL DISTRIBUTION TRANSFORMER SPECIFICATION..... 17

 2.1. Type..... 17

 2.2. Ratings..... 17

 2.3. Through Fault Strength 17

 2.4. Service Conditions..... 17

 2.5. Primary Winding Taps 17

 2.6. Transformer Insulating & Cooling Fluid 17

 2.7. Department of Energy Conservation Standards 18

PART 3 - OVERHEAD DISTRIBUTION TRANSFORMERS SPECIFICATION..... 18

 3.1. High Voltage Windings and Bushings..... 18

 3.2. Low Voltage Windings and Bushings 18

 3.3. Impedance 19

3.4. Accessories..... 19

PART 4 -PAD MOUNTED DISTRIBUTION TRANSFORMER SPECIFICATION 22

4.1. High Voltage Windings and Bushings..... 22

4.2. Low Voltage windings and Bushings 22

4.3. Over-Current Protection 22

4.4. Paint Finish..... 22

4.5. Tamper Resistance..... 23

4.6. Diagrammatic Nameplates 23

4.7. Construction Features – Single Phase..... 23

4.8. Construction Features – Three Phase..... 26

PART 5 - ATTACHMENTS 31

5.1. List of Attachments 31

TABLE OF FIGURES

Figure # 1: Example of a Single Position Mounting 20

Figure # 2: Example of Lightning Arrestor to be installed on Transformer 21

Figure # 3: Example of Mounted Lightning Arrestor 21

Figure # 4: Reference Image from IEEE C57.12.38-2023 24

Figure # 5: Access Port for Temporary Service– Approximate Location..... 25

Figure # 6: Examples of a Primary Switch 26

Figure # 7: Four-Hole Pad for 500kVA and Below..... 28

Figure # 8: Six-Hole Pad for 750kVA through 1000 kVA 28

Figure # 9: Ten-Hole Pad for 1500kVA and Above..... 29

Figure # 10: Vendor Labeling Requirements..... 30

TABLE OF TABLES

Table # 1: Quarterly Adjustment Examples 11

Table # 2: Weighting Percentage Example 11

Table # 3: Pole Type, Single Phase, Primary Rated Voltage..... 14

Table # 4: Pole-Type, Dual-rated Primary Rated Voltage. 15

Table # 5: Pad-mounted, Single-phase Primary Voltage Rated. 15

Table # 6: Pad-mounted Three-phase Primary Rated Voltage. 16

Table # 7: “Micro” Conventional Pole-Type Transformers 16

Table # 8: Impedances for Pole-Type Transformers 19

Table # 9: Single-Phase Pad-Mounted Transformer Impedances..... 25

Table # 10: Three-Phase Transformer Impedances 27

SECTION 337300 – UTILITY TRANSFORMERS

PART 1 - GENERAL CONDITIONS

1.1. Introduction

- A. This specification covers the furnishing and delivery for all newly manufactured Distribution Transformers required by the Vineland Municipal Electric Utility.

1.2. City of Vineland – General Instructions

- A. It shall be each prospective Bidder's responsibility to read and understand the requirements as outlined and set forth in the document entitled "City of Vineland General Instructions" and precedes this specification.
- B. The general conditions outlined in this specification are not intended to duplicate or amend those instructions.
- C. See General Instructions Section III.C related to any request for interpretation or clarification of the meanings contained within this specification.

1.3. Definitions of Terms

- A. Whenever the following terms are used in these specifications or pertaining to these specifications, the following definitions shall apply:
 - i. *City*: The City of Vineland, New Jersey, acting for themselves or through their duly empowered representatives.
 - ii. *VMEU, Utility*: The Vineland Municipal Electric Utility, a department of the City of Vineland.
 - iii. *Contractor*: The successful Bidder to whom a contract is let for the execution of the work described herein.
 - iv. *Manufacturer*: The designer and constructor of the equipment to be supplied herein.
 - v. *Approved*: Having the approval or subject to the approval of the Director of the City of Vineland Electric Utility or his authorized representative.
 - vi. *Suitable, Satisfactory, Proper, Adequate, Acceptable, and terms of like import*: Meeting the requirements of the case in the judgment of the City.
 - vii. *Clarification or clarify*: Use of these words as terms shall be only understood in the context as verbs. Their definition is to make clear or easier to understand or to clear of confusion or uncertainty. The use of these words may not be used to change any of the specification. They may only be used to clear-up a meaning or phrase which the potential Bidder has used.
 - viii. The additional terminology given in the latest revisions of IEEE C57.12.00-2021, "IEEE Standard for General Requirements for Liquid-Immersed Distribution, Power, and Regulating Transformers" and IEEE C57.12.80-2024, "IEEE Standard Terminology for Power and Distribution Transformers" shall apply:

- a. BIL: Basic insulation level.
- b. BSL: Basic switching impulse insulation level.
- c. ETM: Electronic temperature monitor.
- d. GIC: Geo-magnetically induced current.
- e. ONAN: The cooling class for a transformer or reactor having its core and coils immersed in mineral oil or synthetic insulating fluid with fire point less than or equal to 300 °C, the cooling being affected by the natural circulation of air over the cooling surface.
- f. N/O: Normally open.
- g. N/C: Normally closed.
- h. RIV: Radio interference voltage.

1.4. Ownership

- A. Ownership shall remain vested in the manufacturer or contractor until transformers are received and accepted in good condition by VMEU.
- B. Acceptance by VMEU shall in no way relieve the contractor of its responsibilities as defined under these specifications.

1.5. Suspension

- A. The City shall have the power at any time to suspend or discontinue the execution of the work under this contract, and, at its discretion, terminate and vacate said contract, either for neglect or refusal of the contractor to proceed with the work, or for any substantial violation of the covenants, terms, conditions or provisions of the contract, without rendering the City liable for damages therefore.
- B. In case the execution of this contract shall at any time be suspended or discontinued by the direction of Court or permanent injunction, no claims for damages or for prospective profits on work not actually performed shall be made or allowed, but the contractor shall be entitled to reasonable compensation for sales costs, bonds, and other expenses to which may have been put in securing the contract and in making preparations for the carrying out of same, including costs involved in setting up any work facilities and for any materials and or labor actually furnished by the contractor.

1.6. Assigning

- A. The contractor hereunder shall not assign, or transfer to any person, or persons, this contract, nor any of the moneys falling due or to become due hereunder. He shall not give any orders or drafts on the City for any moneys due or to become due under his contract, unless by and with the consent of the City.
- B. The contractor agrees that no person, other than itself, shall have any claim hereunder.

1.7. Repairs and Replacements

- A. The contractor shall make good any defects that may develop in his work or in any materials, parts, or equipment furnished by him for a period of one year from the date of final acceptance. His obligation shall include any and all expense that may be involved in the rectification of such defects. He shall, however, not be required to make repairs or replacements that may be necessary as a result of negligence or improper care or operation on the part of the City or the City's employees, or of ordinary wear and tear.

- B. Neither the final payment, nor any other provision of the contract, nor partial or entire use of the equipment as intended, shall relieve the contractor of liability with respect to the guarantees and warranties referred to in these specifications or any other warranties expressed or implied.

1.8. Codes and Standards

- A. Any references to standards or codes of local or state authorities, shall be references to the latest approved versions as published at the date of taking bids, unless specifically stated otherwise.
- B. The equipment covered by these specifications shall be designed, tested, and assembled in accordance with the latest applicable standards as prepared by but not limited to:
 - i. The American National Standard Institute (ANSI)
 - a. ANSI/NETA ATS: Standard for Acceptance Testing Specifications for Electrical Power Equipment and Systems
 - b. ANSI B1.20.1: Pipe Threads, General Purpose (Inch).
 - ii. American Society of Civil Engineers (ASCE)
 - iii. American Society for Testing and Materials (ASTM International)
 - a. ASTM B62: Standard Specification for Composition Bronze or Ounce Metals Castings.
 - b. ASTM B584: Standard Specification for Copper Alloy Sand Castings for General Applications.
 - c. ASTM D3487: Standard Specification for Mineral Insulating Oil Used in Electrical Apparatus.
 - iv. Institute of Electrical and Electronic Engineers (IEEE) including:
 - a. IEEE 270-2006: IEEE Standard Definitions for Selected Quantities, Units, and Related Terms, with Special Attention to the International System of Units (SI)
 - b. IEEE C57.12.00-2021: IEEE Standard for General Requirements for Liquid-Immersed Distribution, Power, and Regulating Transformers.
 - c. IEEE C57.12.10-2017: IEEE Standard Requirements for Liquid-Immersed Power Transformers.
 - d. IEEE C57.12.20-2023: IEEE Standard for Overhead-Type Distribution Transformers 500 kVA and Smaller: High Voltage, 34 500 V and Below; Low Voltage, 7970/13 800V V and Below
 - e. IEEE C57.12.28-2023: IEEE Standard for Pad-Mounted Equipment – Enclosure Integrity.
 - f. IEEE C57.12.34-2022: IEEE Standard Requirements for Pad-Mounted, Compartmental-Type, Self-Cooled, Three-Phase Distribution Transformers, 10 MVA and Smaller; High-Voltage, 34.5 kV Nominal System Voltage and Below; Low-Voltage, 15 kV Nominal System Voltage and Below
 - g. IEEE C57.12.35-2024: IEEE Standard Bar Coding for Distribution Transformers and Step-Voltage Regulators

- h. IEEE C57.12.38-2025: IEEE Standard for Pad-Mounted-Type, Self-Cooled, Single-Phase Distribution Transformers 250 kVA and Smaller: High Voltage, 34 500 GrdY/19 920 V and Below; Low Voltage, 480/240 V and Below
 - i. IEEE C57.12.39-2017: IEEE Standard for Requirements for Distribution Transformer Tank Pressure Coordination
 - j. IEEE C57.12.70-2020: IEEE Standard for Standard Terminal Markings and Connections for Distribution and Power Transformers.
 - k. IEEE C57.12.80-2024: IEEE Standard Terminology for Power and Distribution Transformers.
 - l. IEEE C57.12.90-2021: IEEE Standard Test Code for Liquid-Immersed Distribution, Power, and Regulating Transformers.
 - m. IEEE C57.13-2016: IEEE Standard Requirements for Instrument Transformers (ANSI).
 - n. IEEE C57.19.01-2017: IEEE Standard for Performance Characteristics.
 - o. IEEE C57.19.100-2012: IEEE Guide for Application of Power Apparatus Bushings.
 - p. IEEE C57.91-2020: IEEE Guide for Loading Mineral-Oil-Immersed Power Transformers.
 - q. IEEE C57.100-2022: IEEE Standard Test Procedure for Thermal Evaluation of Insulation Systems for Liquid-Immersed Distribution and Power Transformers
 - r. IEEE C57.123-2019: IEEE Guide for Transformer Loss Measurement.
 - s. IEEE C62.11-2020: IEEE Standard for Metal-Oxide Surge Arresters for AC Power Circuits (>1kV)
 - t. (IEEE) ANSI C57.12.22-1995: American National Standard for Pad-Mounted, Compartmental-Type, Self-Cooled, Three-Phase Distribution Transformers With High-Voltage Bushings, 2500 kVA and Smaller; High Voltage, 34 500 GrdY/19 920 Volts and Below; Low Voltage, 480 Volts and Below
 - v. National Electrical Manufacturers Association (NEMA) including:
 - a. NEMA 250: Enclosures for Electrical Equipment (1000V Maximum).
 - b. NEMA WC 70/ ICEA S-95-658: Power Cables Rated 2000 Volts or Less for the Distribution of Electrical Energy
 - vi. National Fire Protection Association (NFPA)
 - a. NFPA 70: National Electric Code (NEC) 2026
 - vii. Occupational Safety and Health Administration (OSHA)
 - a. OSHA Rule 1910.269-1994: Electric Power Generation, Transmission, and Distribution: Electrical Protective Equipment
- C. Guarantees, when requested, shall be furnished by the contractor on forms provided or approved by the city's purchasing department and shall be signed by the contractor.

- D. The contractor shall supply test data for each transformer shipped. Testing shall be in accordance with IEEE C57.12.90-2021, or latest revision. The following information shall be supplied:
- i. Date of test
 - ii. Serial No. of transformer(s)
 - iii. Actual No-load losses vs. Quoted No-load losses.
 - iv. Actual Full-load losses vs. Quoted Full-load losses.
 - v. Certification of winding temperature rise.
 - vi. Certification of insulation acceptance test.
 - vii. Certification of non-PCB oil.
 - viii. Name of individual certifying test results.
- E. In the event that actual losses are in excess of guaranteed losses, the contractor shall reimburse VMEU for costs incurred due to higher costs of operation during the life of the transformer as calculated in the present worth formula, which is included as part of these specifications.

1.9. Delivery

- A. All equipment, herein specified, shall be delivered F.O.B., VMEU warehouse at **415 N. West Avenue** (West Avenue and Peach Street), **Vineland, NJ 08360**, Freight Prepaid and Allowed. Ownership shall remain vested with manufacturer until acceptance by VMEU. All claims for recovery of damages shall be the responsibility of the contractor.
- B. All transformers shall be delivered on a flatbed truck accessible by forklift truck or overhead crane.
- C. Contractor shall require shipper to provide VMEU Storekeeper (856) 794-4000 ext. 4811 or 4308) with a minimum of 24-hour notice of transformer delivery so arrangements for lifting equipment can be made. Shipper shall provide VMEU with the weight of each unit and the estimated time of arrival. Contractor shall be responsible for unloading transformers in the event such notice is not received.

1.10. Terms of Payment

- A. For payment to be approved the Contractor must meet the following requirements:
- i. The submission of properly certified invoices for equipment received by VMEU.
 - ii. Testing data per Section 1.8.D.
- B. Once the above are met, payments will be made within thirty (30) days.

1.11. Bidder Requirements

- A. The bidder shall submit with the bid a certification stating the following:
- i. The bidder is authorized to offer the specified quantities under the specified conditions at the price bid.
 - ii. The manufacturer fully warrants the equipment directly to VMEU as to the quality and suitability for the intended use.

- iii. The manufacturer will supply directly to VMEU, without additional charge, all engineering services required by VMEU for the application and operation of the equipment specified for the life of the contract. Access to the manufacturer's engineering department through direct contact with the manufacturer's utility sales representative for the equipment specified shall be considered to meet these requirements.
- B. The manufacturer shall be a recognized supplier of transformers and related services to the electric utilities in the PJM area as listed below. The bidder shall submit a list of the PJM utilities where the manufacturer is on the "Approved Supplier" list (or successor company's names) for the type of transformers to be supplied.
- i. Atlantic City Electric (a.k.a. PEPCO, Exelon)
 - ii. Public Service Electric and Gas Company (a.k.a. PSE&G of New Jersey)
 - iii. Metropolitan Edison Company (a.k.a. First Energy)
 - iv. Pennsylvania Electric Company (a.k.a. PEC)
 - v. Philadelphia Electric Company (a.k.a. PECO, Exelon)
 - vi. Baltimore Gas and Electric Company (a.k.a. BGE, Exelon)
 - vii. Commonwealth Edison Company (a.k.a. Com Ed)
 - viii. Consolidated Edison Company of New York (a.k.a. Con Edison or Con Ed of NY)
 - ix. Long Island Lighting Company (a.k.a. Long Island Power Authority)
 - x. Orange & Rockland Utilities (a.k.a. Consolidated Edison, Inc.)
 - xi. Jersey Central Power & Light (a.k.a. JCPL)

1.12. Transformer Data

- A. The following data is to be supplied with the bid for the transformers tabulated in the Proposal Supplementary Data:
- i. Guaranteed no load losses (watts).
 - ii. Guaranteed full load losses (watts).
 - iii. Guaranteed total losses (watts).
 - iv. Impedance.
 - v. Weight of completely assembled and filled transformer.
 - vi. Data or reference to data submitted previously will be unacceptable by VMEU and will be considered grounds for rejection of bids.
 - vii. The contractor will be required to supply dimensional drawings of pad-mounted transformers along with the manufacturers recommended pad-mount foundation dimensions for all pad-mounted transformers supplied under the contract. These drawings must be submitted with the Contractor's Order Acknowledgment.

1.13. Proposals

- A. Proposals shall be made on the electronic files included separately. Examples of these pages are included here. For type of transformer being quoted, the Bidder will include
- i. Core type;
 - ii. No-Load Losses (in Watts);

- iii. Full-Load Losses (in Watts);
 - iv. The Impedance for transformer being quoted (per appropriate type & size from Tables 8, 9, or 10);
 - v. Weight for the type of transformer being quoted;
 - vi. Estimated delivery “after receipt of order”;
 - vii. Price for each transformer being quoted;
 - viii. Pricing & Delivery terms for each proposal;
 - ix. Option year pricing.
- B. The Total Weighted Price (Unit Price X Weighted Value) and the Total Bid is automatically calculated.
 - C. When each proposal is printed out, the date and time printed are included.
 - D. Each proposal shall be signed by an authorized representative of the Bidder.
 - E. Alternate proposals shall be accepted and evaluated on an equal footing.
 - F. The Bidder’s bid guarantee shall apply to all proposals submitted. In other words, the Bidder cannot withdraw any proposal without forfeiting the bid guarantee.
 - G. For bids with first year firm pricing, the option year may be subject to a fixed escalator and must be quoted with the bid.
 - H. Bids with first year unlimited escalation may be extended for the option year under the same pricing terms and conditions.
 - I. Bidder shall provide an estimated delivery period on an item-by-item basis as provided on proposal forms. The delivery period shall be defined as the number of days (not weeks), including holidays and weekends, between Contractor’s receipt of purchase order release or verbal confirmation, and actual receipt of transformer(s) at VMEU warehouse. Bids which are subject to escalation shall not be allowed beyond the estimated delivery periods.
 - J. Bidder shall provide the documentation requested in Section 1.12.
 - K. For bids which are subject to escalation, the Bidder must submit all indexes, data and costing sheets which establish the base index upon which the bids are based. These will be part of the “bid package” submitted by each Bidder. It is NOT acceptable to say “see manufacture’s on-line index” since this is subject to change by the manufacturer between the time bids are prepared and when the bids are opened.

1.14. Releases

- A. This order or release will be a Purchase Order issued by the City’s Purchasing Department. The Purchase Order will reference the contract number assigned by the City, the specific transformers that will be ordered, a brief description of the unit, and the bidder references.
- B. A Contract number will be used for this contract. That number will be assigned by the City’s Purchasing Agent.

- C. Each individual order or release for transformers, will be assigned a purchase order number by the City of Vineland.
- D. All invoices and other documents received from the successful vendor must bear the purchase order number for each individual order.

1.15. Pricing Terms and Conditions

- A. Firm pricing is preferred.
- B. Bids which are subject to escalation (or de-escalation) shall be done on a quarterly basis.
- C. Pricing shall be firm for the quarter and will be applied in the quarter the transformers are ordered.
- D. Adjustments shall **NOT** be made during the quarter in which the transformers are shipped.
- E. The percent of adjustment shall be published during the first seven (7) days of the last month prior to the start of the quarter. Example of each quarter:

Table # 1: Quarterly Adjustment Examples

Quarter	Applied to orders placed during this period	Publication Date of percent adjustment
1st	Jan 1st to Mar 31st	First 7 days in Dec
2nd	Apr 1st to Jun 30th	First 7 days in Mar
3rd	Jul 1st to Sep 30th	First 7 days in Jun
4th	Oct 1st to Dec 31st	First 7 days in Sep

- F. An example of the percentage weighting applied to each price index follows:

Table # 2: Weighting Percentage Example

Commodity Index	% Change from Base Index	Weighting Factor (Material Cost as a % of Price)	Weighted % Change
Carbon Steel	48.57	8.20%	3.9827
Silicon or Amorphous Core Steel	74.39	18.80%	13.9853
Copper	114.03	4.20%	4.7893
Aluminum	86.57	6.30%	5.4539
Insulating medium (dielectric fluid)	202.38	6.60%	13.3571
All other materials, labor, transportation, overhead, and	0.00	55.90%	0.0000
Transformer Surcharge Index	XXXXXXXXXX	100.00%	41.5683

- G. Reference data for the commodities above (Section 1.15.F.)
 - i. Bidders may use their standard commodity or standard publicly published indices. The Bidder MUST supply the exact name of the index and the current value used in determining “% Change for Base Index”. A copy of this MUST be provided with the Bidders bid package.
- H. The total of the weighting factors column (Section 1.15.F.) must be 100%.
- I. The “Weighted % Change” is derived by multiplying the plus or minus “% Change” by the “Weighting Factor”.
- J. The “Transformer Surcharge Index” (TSI) is the total sum of the “Weighted % Change”.
- K. All bid unit prices will be evaluated using the present worth formula in Section 1.16 (Evaluation of Bids), paragraph D.

1.16. Evaluation of Bids

- A. Bids subject to price escalation shall have bid prices adjusted upwards (for evaluation purposes only) by adding 6% for calendar year escalation. Bids subject to escalation for part of the base year shall be adjusted upward by prorating the 6% adder in accordance with Bidder’s terms. Firm pricing (for a period of 12 months from date of award) shall not be adjusted for price escalation.
- B. Each proposal shall be evaluated separately and awarded on such basis.
- C. The Utility will evaluate and award bids for each major category when practicable but reserves the right to award in total or by an item-by-item basis, whichever is deemed in the Utility’s interest.
- D. The Cost of Ownership (for over a period of 20.5 years) of individual transformers will be calculated utilizing the following formula:

$$PW = (\text{Bid Price or Adjusted Bid Price of Transformer}) + [20.5 \times \{(\text{No Load Losses} \times \$5.7139) + (\text{Full Load Losses} \times \$0.9142)\}]$$
- E. Individual proposals will be evaluated by summing the products of the calculated present worth (PW) and corresponding weighting value of each item as indicated on proposal sheet.
- F. The Utility reserves the right to reject any (and) all bids.
- G. Each Bidder must recognize that the Utility is unable to order a “truckload” of transformers.

1.17. Exception to Bids

- A. Bidder shall state with the bid proposal that he has complied with this specification. If any exceptions are taken with any part of these specifications, they shall be explicitly tabulated and referenced and entitled “Exceptions to Bid Specifications.”
- B. Printed Terms and Conditions: The inclusion of the manufacturer’s standard terms and conditions will be viewed as an exception to the bid specifications. In other words, unless the Bidder takes explicit exception to a specific term or condition of the Bid specification, the Bid specification shall prevail. If “wholesale” or “blanket” exceptions are taken, for example, “proposal is contingent upon acceptance of the enclosed

manufacturers standard terms and conditions," the bid is subject to being rejected without further consideration.

- C. If any exception to the bid specification is taken, alternate language or a remedy must be proposed. If such remedy is deemed to meet the intent of the bid specifications and does not place any other Bidder at a disadvantage (alternately, does not give the Bidder taking the exception an advantage), it will be accepted; otherwise, the bid will be rejected.
- D. Laws mandated by the State of New Jersey which affect, cover, or provide for Public Purchasing regulations shall prevail in all cases.

1.18. Contract Period

- A. Initial Contract Period. Provided contract pricing is maintained as stated herein, the contract shall be for a period of one year and shall commence the day after Vineland's City Council has approved, by Resolution, the award of a contract. This award also has an option to renewal for one (1) addition year.
- B. This "option year" shall NOT be considered an "automatic" contract renewal.
- C. Either party, the City Department or Vendor may elect NOT to enter the "option year". This decision will be made at least 90 days prior to the end of the "initial year".
- D. The maximum length of the contract from this specification, including the option year, is two (2) years.

1.19. Estimated Quantities

- A. Bidders – We can NOT guarantee, we will order all of the sizes and types of transformers listed below, during the contract.
- B. The "weighted values" indicated, on the proposal forms, represent the relative ordering quantity. Actual quantities ordered, per individual releases, shall be in accordance with VMEU's operational needs. The minimum ordering quantity for each item is ZERO. Actual ordering quantities, on an item-by-item basis, may exceed the weighted values as indicated.

C. Tables of quantities

Table # 3: Pole Type, Single Phase, Primary Rated Voltage

Item	KVA	Primary Voltage	Secondary Voltage	Weighted Qty for Spec (Evaluation purposes ONLY)	IEEE C57.12.20-2023 Figure
1A	15	12470GrdY / 7200	120/240	35	8
1B	25	12470GrdY / 7200	120/240	75	8
1C	37.5	12470GrdY / 7200	120/240	50	8
1D	50	12470GrdY / 7200	120/240	30	8
1E	75	12470GrdY / 7200	120/240	13	8
1F	100	12470GrdY / 7200	120/240	5	8
1G	25	12470GrdY / 7200	277	5	8
1H	37.5	12470GrdY / 7200	277	5	8
1I	50	12470GrdY / 7200	277	5	8
1J	75	12470GrdY / 7200	277	5	8
1K	100	12470GrdY / 7200	277	5	8
1L	100	12470 / 21600Y	120/240	3	11
1M	100	12470 / 21600Y	277	3	11
1N	100	12470 / 21600Y	240/480	3	11
1O	167	12470 / 21600Y	120/240	3	11
1P	167	12470 / 21600Y	277	3	11
1Q	167	12470 / 21600Y	240/480	3	11
1R	167	7200 / 12470Y	2400/4160Y	3	11
1S	250	12470 / 21600Y	120/240	3	11
1T	250	12470 / 21600Y	277	3	11
1U	250	12470 / 21600Y	240/480	3	11

Table # 4: Pole-Type, Dual-rated Primary Rated Voltage.

Item	KVA	Primary Voltage	Secondary Voltage	Weighted Qty for Spec (Evaluation purposes ONLY)	IEEE C57.12.20-2023 Figure
2A	15	4160GrdY/2400 X 12470GrdY/7200	120/240	15	8
2B	25	4160GrdY/2400 X 12470GrdY/7200	120/240	30	8
2C	37.5	4160GrdY/2400 X 12470GrdY/7200	120/240	10	8
2D	50	4160GrdY/2400 X 12470GrdY/7200	120/240	10	8
2E	75	4160GrdY/2400 X 12470GrdY/7200	120/240	3	8
2F	100	4160GrdY/2400 X 12470GrdY/7200	120/240	3	8
2G	25	4160GrdY/2400 X 12470GrdY/7200	277	7	8
2H	37.5	4160GrdY/2400 X 12470GrdY/7200	277	7	8
2I	50	4160GrdY/2400 X 12470GrdY/7200	277	5	8
2J	75	4160GrdY/2400 X 12470GrdY/7200	277	6	8
2K	100	4160GrdY/2400 X 12470GrdY/7200	277	4	8
2L	25	2400/4160Y X 7200/12470Y	240/480	3	11
2M	37.5	2400/4160Y X 7200/12470Y	240/480	3	11
2N	75	2400/4160Y X 7200/12470Y	240/480	3	11
2O	100	2400/4160Y X 7200/12470Y	240/480	3	11

Table # 5: Pad-mounted, Single-phase Primary Voltage Rated.

Item	KVA	Primary Voltage	Secondary Voltage	Weighted Qty for Spec (Evaluation purposes ONLY)
3A	25	12470GrdY / 7200	240/120	10
3B	37.5	12470GrdY / 7200	240/120	42
3C	50	12470GrdY / 7200	240/120	24
3D	75	12470GrdY / 7200	240/120	12
3E	100	12470GrdY / 7200	240/120	4
3F	167	12470GrdY / 7200	240/120	1
3G	37.5	4160GrdY/2400 X 12470GrdY/7200	240/120	2
3H	50	4160GrdY/2400 X 12470GrdY/7200	240/120	2
3I	75	4160GrdY/2400 X 12470GrdY/7200	240/120	2
3J	100	4160GrdY/2400 X 12470GrdY/7200	240/120	1

Table # 6: Pad-mounted Three-phase Primary Rated Voltage.

Item	KVA	Primary Voltage	Secondary Voltage	Weighted Qty for Spec (Evaluation purposes ONLY)
4A	150	12470GrdY / 7200	208Y/120	5
4B	150	4160GrdY/2400 X 12470GrdY/7200	208Y/120	1
4C	150	12470GrdY / 7200	480Y/277	1
4D	225	12470GrdY / 7200	208Y/120	2
4E	300	12470GrdY / 7200	208Y/120	4
4F	300	4160GrdY/2400 X 12470GrdY/7200	208Y/120	1
4G	300	12470GrdY / 7200	480Y/277	5
4H	300	4160GrdY/2400 X 12470GrdY/7200	480Y/277	1
4I	500	12470GrdY / 7200	208Y/120	1
4J	500	12470GrdY / 7200	480Y/277	3
4K	750	12470GrdY / 7200	480Y/277	3
4L	1000	12470GrdY / 7200	480Y/277	3
4M	1500	12470GrdY / 7200	480Y/277	2
4N	2000	12470 Delta	480Y/277	1
4O	2500	12470 Delta	480Y/277	1

Table # 7: “Micro” Conventional Pole-Type Transformers

Item	KVA	Primary Voltage	Secondary Voltage	Weighted Qty for Spec (Evaluation purposes ONLY)	IEEE C57.12.20-2023 Figure
MA	1	12470GrdY/7200	120	10	8
MB	1-1/2	12470GrdY/7200	120	10	8
MC	3	12470GrdY/7200	120	10	8
MD	5	12470GrdY/7200	120/240	10	8

PART 2 - GENERAL DISTRIBUTION TRANSFORMER SPECIFICATION

2.1. Type

- A. All transformers shall be for 60 Hz operation with polarity conforming to industry standards.

2.2. Ratings

- A. All capacity ratings shall be continuous at the rated voltage with a maximum 65 degrees C rise above a 30 degree C average, 40 degrees C maximum temperature for a 24-hour period.
- B. All voltage and BIL ratings shall be in accordance with the latest IEEE standards.

2.3. Through Fault Strength

- A. The transformer furnished under this specification shall be so designed and constructed as to be capable of withstanding, without damage, the mechanical and thermal stresses caused by short circuits external to the transformer during its life expectancy as defined below in section 2.4.

2.4. Service Conditions

- A. Life expectancy: 20.5 Years
- B. Anticipated maximum system fault capability at high voltage terminals:
 - i. 7200/12470Y systems: 750MVA.
 - ii. 2400/4160Y systems: 250MVA.

2.5. Primary Winding Taps

- A. With the exception of the micro conventional pole-type transformers (Items MA through MD), all units will be required with standard, externally operated, no-load primary taps. Tap configuration shall be (2) 2 ½ % above rating and (2) 2 ½ % below rating with position 3 or C being 100% rating.
- B. On dual-voltage rated transformers, taps shall be operable in the series (high voltage) connection.
- C. When the dual-voltage switch is set in the parallel (low voltage) position, the tap changer shall be electrically isolated allowing the transformer to be operated safely in any tap position. A true dual-voltage tap changer, fully operable in the high and low voltage settings is acceptable in lieu of the above.

2.6. Transformer Insulating & Cooling Fluid

- A. Group A – The dielectric coolant in the transformer must be highly refined Type II inhibited new mineral oil and meet the minimum requirements as specified in Table 1, "Functional Property Requirements," of ASTM D3487 (latest edition) and ANSI C57.106 (latest edition).

2.7. Department of Energy Conservation Standards

- A. All manufacturers shall have a plan in place to meet the Department of Energy, 10 CFR Part 431 Energy Conservation Program for Commercial Equipment: Distribution Transformers Energy Conservation Standards; Final Rule dated April 18, 2013 (or latest revision).
- B. All transformers supplied by the successful Bidder during the contract period (see Section 1.18) covered by this specification, will meet the above DOE transformer standard requirements.

PART 3 - OVERHEAD DISTRIBUTION TRANSFORMERS SPECIFICATION

3.1. High Voltage Windings and Bushings

- A. Transformers may be required with dual primary voltage ratings. Units shall have one (1) or two (2) primary bushings.
 - i. Proposal Micro -
 - a. Items MA through MD shall have one (1) primary pole-type bushing.
 - ii. Proposal 1A –
 - a. Items 1A through 1L shall have one (1) primary pole-type bushing.
 - b. Items 1K through 1U shall have two (2) primary pole type bushings.
 - iii. Proposal 2A –
 - a. Items 2A though 2K shall have one (1) primary pole-type bushing.
 - b. Items 2L through 2O shall have two (2) primary pole-type bushings.
- B. All primary bushings are to be wet-process porcelain type with tin-plated clamp-type terminals, unless specified otherwise.

3.2. Low Voltage Windings and Bushings

- A. Low voltage windings will be rated 120/240, 240/480, or 277/480Y as tabulated on the Proposal sheet.
- B. Transformers shall be equipped with EEI-NEMA standard mounting arrangements.
- C. Transformers up to 100 kVA shall be equipped with tin plated, clamp-type secondary terminals.
- D. Transformers 167 kVA and above shall be equipped with tin-plated, NEMA standard 4-hole spades.
- E. There shall be neutral ground straps on the neutral secondary bushing (see figure #2) of all pole-type transformers. VMEU understands this is above IEEE standard requirements.
- F. For transformers 167 kVA and a secondary voltage of 2400/4160Y
 - i. Shall have side-wall mounted secondary bushings,
 - ii. Secondary voltage windings will be rated 2400/4160Y in accordance with the applicable IEEE standard.

- iii. The secondary bushings shall be so that the secondary voltage could be single phase 2400 Delta (neither secondary bushing grounded) or single phase 2400 grounded Y (grounding only one of the secondary bushing).
- iv. The secondary bushings are to be wet-process porcelain type with tin-plated, clamp type terminals that fully comply with the applicable IEEE standard.

3.3. Impedance

- A. The “tolerance of impedance” shall be per IEEE C57.12.00-2021 (or latest edition) section 9.2.
- B. As of June 5, 2014, that value is interpreted to be +/- 7.5% for units with impedance of greater than 2.5% and +/- 10% for units with impedance of 2.5% or less. The absolute minimum and maximum impedance shall be within the percent impedances noted below.
- C. The impedances for pole-type transformers shall be as follows in Table 8:

Table # 8: Impedances for Pole-Type Transformers

	KVA Range	Secondary Voltage	% IZ	+/- % Tolerance of Z	Absolute Minimum % IZ	Absolute Maximum % IZ
i.	1kVA - 3kVA	120	1.50%	10%	1.3500%	1.6500%
ii.	5kVA	120	1.75%	10%	1.5750%	1.9250%
iii.	15kVA - 25kVA	120/240	1.50%	10%	1.3500%	1.6500%
iv.	15kVA - 75kVA	240/480 or 277/480Y	1.50%	10%	1.3500%	1.6500%
v.	37.5kVA - 50kVA	120/240	1.75%	10%	1.5750%	1.9250%
vi.	75kVA - 100kVA	120/240	2.00%	10%	1.8000%	2.2000%
vii.	100kVA	240/480 or 277/480Y	1.75%	10%	1.5750%	1.9250%
viii.	167kVA	2400/4160Y	3.50%	7.5%	3.2375%	3.7625%

3.4. Accessories

- A. All transformers shall be equipped with fault pressure relief valves.
- B. Covers and cover bands shall be coated with an insulating material to prevent transformer outages caused by birds and squirrels.
- C. Cover band shall be single-piece design constructed of stainless steel, secured by a slotted, hex-head, stainless steel bolt.
- D. All transformers shall be a visible cover ground to the tank.
- E. All transformers shall be equipped with a tank grounding lug located adjacent to lower hanging bracket.

- F. All transformers shall be equipped with welded NEMA standard lifting lugs and single hanger brackets per IEEE C57.12.20-2023 (or latest edition). Dual or double sets of hanger brackets are not permitted.

In addition, the “Micro” pole type transformers in Proposal Micro, may be provided with only **ONE** hanger bracket instead the traditional.

Figure # 1: Example of a Single Position Mounting

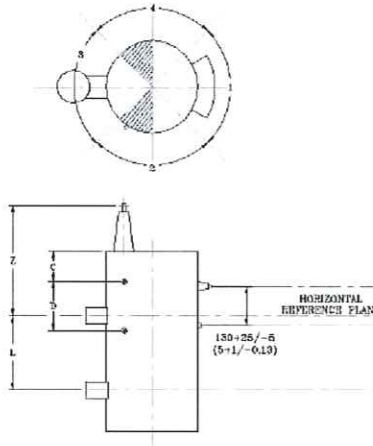

- G. Nameplates shall be located in an easy-to-read position on either the lower hanger bracket or on a bracket mounted on the lower part of the transformer tank.
- H. All transformers shall have the unit’s kVA rating clearly marked on the tank below the secondary bushings, such that after a transformer is mounted on a pole at a height of 35 feet, the kVA rating can be read by a person standing at grade level.
- I. Color: Gray, ANSI 70.
- J. All units shall have a “Blue” non-PCB label affixed to the tank in a location easily spotted by a person standing at grade level with the unit mounted on a pole at a height of 35 feet.
- K. For overhead pole-type, single phase primary rated in Proposal #1 and dual voltage rated in Proposal #2.
 - i. These transformers shall have the distribution lightning arrester installed directly on the transformer. This is only for the transformers in Proposal #1 and Proposal #2. See Figure 2.
 - ii. The arresters shall be connected to the primary bushing via a covered lead wire rated for this application and use.
 - iii. The isolators of each arrester shall be connected to case ground of the transformer. It shall be installed in such a manner so the isolator will not end up on top of the transformer as a result of separating from the arrester body due to a fault.
 - iv. Those transformers whose voltage would be considered Delta primary (two bushing

transformers), shall have the same lightning arrester used only on the H1 bushing. Do **NOT** place an arrester on the H2 bushing. VMEU shall install the second lightning arrester as needed. Reference: Proposal #1, Items 1L through 1R. Proposal #2, Items 2L through 2O.

- v. The mounting configurations shown in Figures 1 and 2 are intended as examples only and not a final design.

Figure # 2 - Example of Lightning Arrester to be installed on Transformer

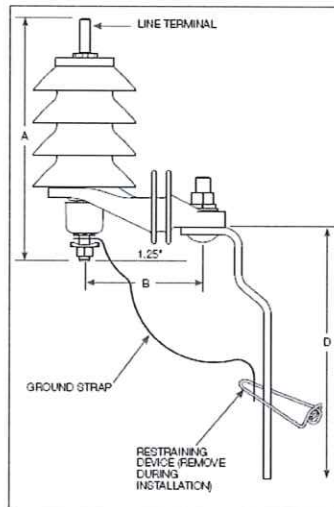

- vi. Arresters shall be equal to:
 - a. Hubbell Power Systems #213709-7533
 - b. Eaton (a.k.a. Cooper Power Systems) #UHS1005-3A1C-1DXX1A
 - c. MacLean Power Systems (a.k.a. Joslyn Mfg) #ZHP010-0N12112B
 - d. Siemens Pwr #3EK8100-3CA4-Z-M11/M51/P12/P31/P52/Q11

Note: To be included – Ground strap from isolator to tank and wire lead from top terminal to top of H1 bushing.

Figure # 3: Example of Mounted Lightning Arrester
(Note: Item #21 is the transformer ground Strap)

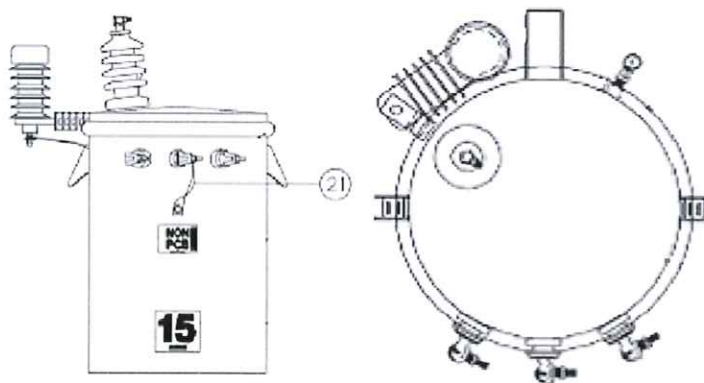

PART 4 -PAD MOUNTED DISTRIBUTION TRANSFORMER SPECIFICATION

4.1. High Voltage Windings and Bushings

- A. All transformers shall be dead-front and conform to IEEE requirements. IEEE C57.12.38-2025 (or latest edition thereof) for pad-mounted, single phase distribution transformers Table 3.
- B. All transformers shall be provided with externally clamped, 200 Ampere, universal-type bushing wells (dry wells), complete with 200 ampere load break inserts installed with dust covers. The bushing design shall incorporate an externally removable stud, designed for easy replacement in the event of stud damage or breakage.
- C. All transformers shall be equipped with sufficient number of parking stands; at least one for each primary terminal position.
- D. All transformers shall be loop-feed design.

4.2. Low Voltage windings and Bushings

- A. Bushings shall be externally clamped to the tank wall.
- B. The neutral bushing (Xo) on secondary of all pad-mounted transformers shall be solidly connected to ground via a grounding strap.

4.3. Over-Current Protection

- A. All pad-mounted transformers must withstand, without rupture or catastrophic failure, an internal fault with available energy as stipulated under "Section 2.4, Service Conditions."
- B. All pad-mounted transformers shall be protected from internal faults by use of a liquid immersed partial range current limiting fuse (Eaton / Cooper Power Systems ELSP or equal). The partial range current limiting fuse shall be mounted as near as possible to the primary bushing to which it is connected.
- C. The partial range current limiting fuse shall be coordinated with a bay-o-net primary fuse such that a secondary fault will not damage the CL fuse. The bay-o-net fuse holder shall contain a flapper valve and oil drip catch in order to minimize the possibility of an oil discharge.
- D. Dual Voltage Units – When transformers are set in the low voltage (4160GrdY/2400) position, it is acceptable to require a change in bay-o-net fuse size in order to achieve the required fuse coordination. Transformers shall be shipped with the proper bay-net fuse for 12,470GrdY/7,200 operation. The fuses for 4,160GrdY/2,400 volt operation shall be included and stored in the transformer with the required fuse sizes permanently marked at the dual voltage switch.

4.4. Paint Finish

- A. Transformers shall have a high-performance paint finish suitable for general outdoor use.
- B. The manufacturer shall supply a 5-year warranty against excessive finish degradation and rust-through.

- C. Color: All pad-mounted transformers shall be Olive Green, Munsell 7 GY 3.20/1.5.

4.5. Tamper Resistance

- A. All transformers shall be manufactured in accordance with the latest NEMA, IEEE, and ASTM standards pertaining to the design, performance, and security of pad-mounted transformers.

4.6. Diagrammatic Nameplates

- A. Diagrammatic Nameplates shall be installed both on exterior and interior door of the low voltage compartment. The use of glue or two-sided adhesive tapes are unacceptable methods of attaching diagrammatic nameplates on the exterior door of the low voltage compartment. Use of "pop-rivets" is an acceptable method or such type method as to where the nameplate can be permanently installed/attached on the exterior of the low voltage door.
- B. The diagrammatic nameplates for single phase pad-mount transformers shall be affixed per drawing in Figure 9 (entitled "Vendor Labeling Requirement").

4.7. Construction Features – Single Phase

- A. All single-phase pad-mounted transformers shall be equipped with a load break primary or secondary hook stick operable switch (a secondary breaker is acceptable) to facilitate service connections. If a secondary breaker is used, it should be coordinated to protect the bay-o-net fuse for overloads. However, the bay-o-net fuse may clear before the secondary breaker in order to protect the current limiting fuse during secondary faults. An Eaton (aka Cooper Power Systems) "MagneX"™ switch may be substituted in lieu of the bay-o-net fuse and secondary breaker.
- B. Single-phase transformers shall have 240/120 volt rated secondary windings.
- C. Single-phase transformers shall have IEEE Type 2, interchangeability dimensions; per C57.12.38-2025 (latest revision).
- D. Single-phase transformers shall have provisions for two (2) parking stands are required instead of one (1) as shown in Figure 4, Detail "B," on page 21 of IEEE C57.12.38-2025. VMEU uses both parking positions.

Figure # 4: Reference Image from IEEE C57.12.38-2025

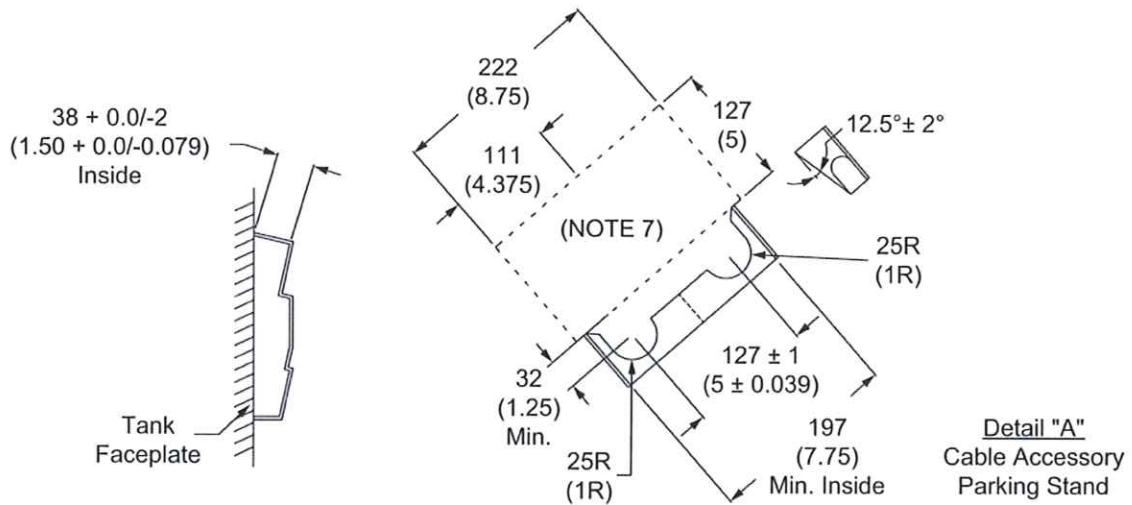

- E. Single-phase transformers shall have threaded stud and “jam-nut” sizes as referenced per IEEE C57.12.38-2025, Figure 7 (or latest edition). VMEU shall install secondary terminals of its selection.
- F. Single-phase transformers, 100kVA and above, shall have threaded copper stud and “jam-nut” sizes as referenced per IEEE C57.12.38-2014, Figure 7 (or latest edition) equipped with removable tin-plated H-spade (4-hole square, NEMA) secondary terminals.
- G. Single phase pad-mounted transformers shall be a low-profile design and have all-welded construction flip-up doors that accept standard pad locks, and shall be secured with penta-head bolt.
- H. A 2.25 inch access shall be provided on the lower right side towards the front of the transformer base (Not in the lid) to allow emergency access to the transformer secondary. The access shall be covered from inside the transformer secondary compartment with a removable plate secured by bolts which can't be removed from the outside (or exterior) of transformer (Reference Figure 5).

Figure # 5: Access Port for Temporary Service– Approximate Location

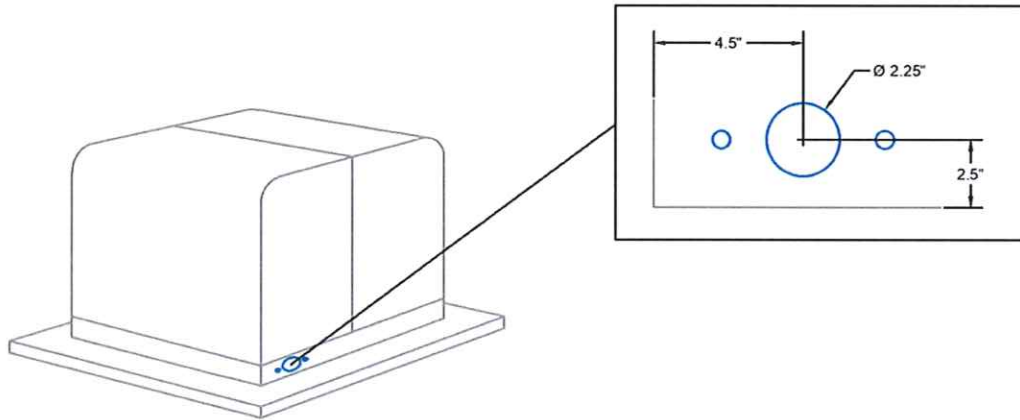

- I. Markings: All units shall have affixed to the front of the flip-up door a blue “Non-PCB” label and a bilingual voltage warning decal. The labeling shall be affixed per drawing in Figure 9 (entitled “Vendor Labeling Requirement”).
- J. Single-phase pad-mounted transformers shall have the following:
 - i. Pressure relief device.
 - ii. Grounding lug.
 - iii. Lifting eye/hook provisions.
 - iv. Oil drain plug.
- K. Impedance
 - i. The “tolerance of impedance” shall be per IEEE C57.12.00-2021 (or latest edition) section 9.2.
 - ii. As of December 24, 2009, that value is interpreted to be +/- 10% of the percent impedances noted below.
 - iii. The impedances for single-phase pad-mounted transformers shall be as follows in Table 9:

Table # 9: Single-Phase Pad-Mounted Transformer Impedances

	KVA Range	% IZ	+/- % Tolerance of IZ	Absolute Minimum % IZ	Absolute Maximum % IZ
i.	25kVA - 50kVA	1.75%	10%	1.5750%	1.9250%
ii.	75kVA and above	2.00%	10%	1.8000%	2.2000%

- L. There shall be a hole drilled into the front of all single-phase pad-mount transformers per Figure 9 (entitled “Vendor Labeling Requirement”). This hole shall be plugged with a removable bolt to prevent “probe” access except with the bolt physically removed. This bolt shall be the type which can’t be removed with the transformer’s access compartment hood in the “CLOSED” position.

4.8. Construction Features – Three Phase

- A. Three-phase transformers shall have 208Y/120 or 480Y/277 volt rated secondary windings.
- B. Three-phase transformers shall be equipped with tin-plated spade type terminals; 112.5kVA through 500kVA shall have 4-hole NEMA spades (see Figure 7); 750kVA and 1000kVA shall have 6-hole NEMA spades (see Figure 7); 1500kVA and above shall have 10-hole NEMA spades (see Figure 8) with bushing supports.

Special Note: All bushings shall be designed in accordance with enclosed drawings in order to accommodate the use of current transformers. It is acceptable to have more NEMA pair holes in the bushing in order to accommodate this requirement.

- C. It is desired that all 3Ø transformers be designed using bay-o-net fusing along with over current protection as described in Section 4.3, paragraph C.
- D. Transformers 300 kVA and below, and 500 kVA with 480Y/277 secondary will have two-piece low voltage bushings with studs and screw on spades. Transformers 500 kVA with 208Y/120 secondary and all transformers above 500 kVA will have one-piece bushings.
- E. Three-phase transformers shall be provided with secondary bushings in a staggered arrangement per Figure 4 (A), IEEE C57.12.34-2022.
- F. Three-phase transformers primary bushing heights shall be per Figure 16, IEEE C57.12.34-2022 (or latest revision) for 15kV loop feed transformers.
- G. Transformers up to 500kVA shall have a one-inch drain plug. Units 750kVA and above shall be equipped with a one-inch drain valve and sampler.
- H. Transformers 1500kVA and above shall have the following:
 - i. Liquid level gauge,
 - ii. Dial type thermometer,
 - iii. 4-position load break switch, V-blade design with “make-before-break” option, and descriptions of switch positions such as shown in Figure 6:
 - a. Feed from A & B
 - b. Feed from A only
 - c. Feed from B only
 - d. Open — the loop is **open** and the transformer is de-energized

Figure # 6: Examples of a Primary Switch

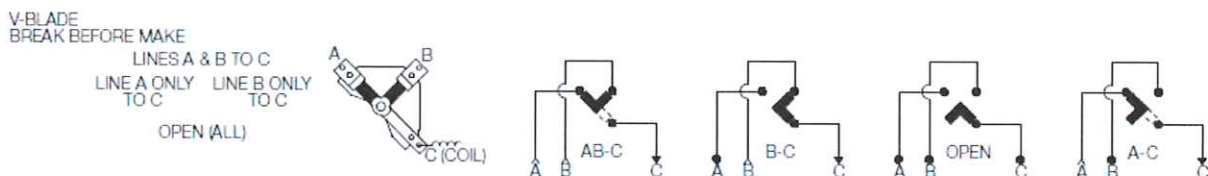

- iv. Some manufacturers have indicated problems in coordinating bay-O-net fusing for this range of transformer sizes. In that case, the Eaton (aka Cooper Power Systems) high ampere overload bay-O-net fuse link (see Cooper bulletin #240-49 for application use) and corresponding bay-o-net fuse holder for high current applications shall be used.
- v. Over current protection, as described in Section 4.3, is still to be used in the design.
- I. The transformer and associated compartments shall be assembled as an integral unit with no exposed screws, bolts, or other fastening devices that are externally removable.
- J. The high and low voltage compartments shall be located side by side and separated by a steel barrier. Compartments shall be full height, air filled with individual doors.
- K. The high voltage compartment shall be located on the left side. This compartment shall have a side-mounted hinged door with a penta-head fastening bolt which is accessible only after the secondary compartment is open. The low voltage door shall have a three-point latching cabinet handle mechanism, secured with a penta-head bolts and provisions for a single padlock. With door in the open position, door's hood, and front sill shall be removable to facilitate wire pulling.
- L. Transformers shall be equipped with a pressure relief valve.
- M. Transformers shall be equipped with two grounding lugs located one each in primary and secondary compartments.
- N. Transformers shall have NEMA Standard welded lifting lugs.
- O. Markings - All units shall have affixed to the exterior of the secondary compartment door a "Blue" Non-PCB label and a bilingual voltage warning decal.
- P. Impedance
 - i. The "tolerance of impedance" shall be per IEEE C57.12.00-2021 (or latest edition) section 9.2.
 - ii. As of December 24, 2009, that value is interpreted to be +/- 10% of the percent impedances noted below.
 - iii. The impedances for three-phase transformers shall be as follows in Table 10:

Table # 10: Three-Phase Transformer Impedances

	KVA Range	% IZ	+/- % Tolerance of IZ	Absoulute Minimum % IZ	Absoulute Maximum % IZ
i.	150kVA - 300kVA	1.50%	10%	1.3500%	1.6500%
ii.	500kVA	2.00%	10%	1.8000%	2.2000%
iii.	750kVA & above	5.75%	10%	5.1750%	6.3250%

Figure # 7: Four-Hole Pad for 500kVA and Below

Figure # 8: Six-Hole Pad for 750kVA through 1000 kVA

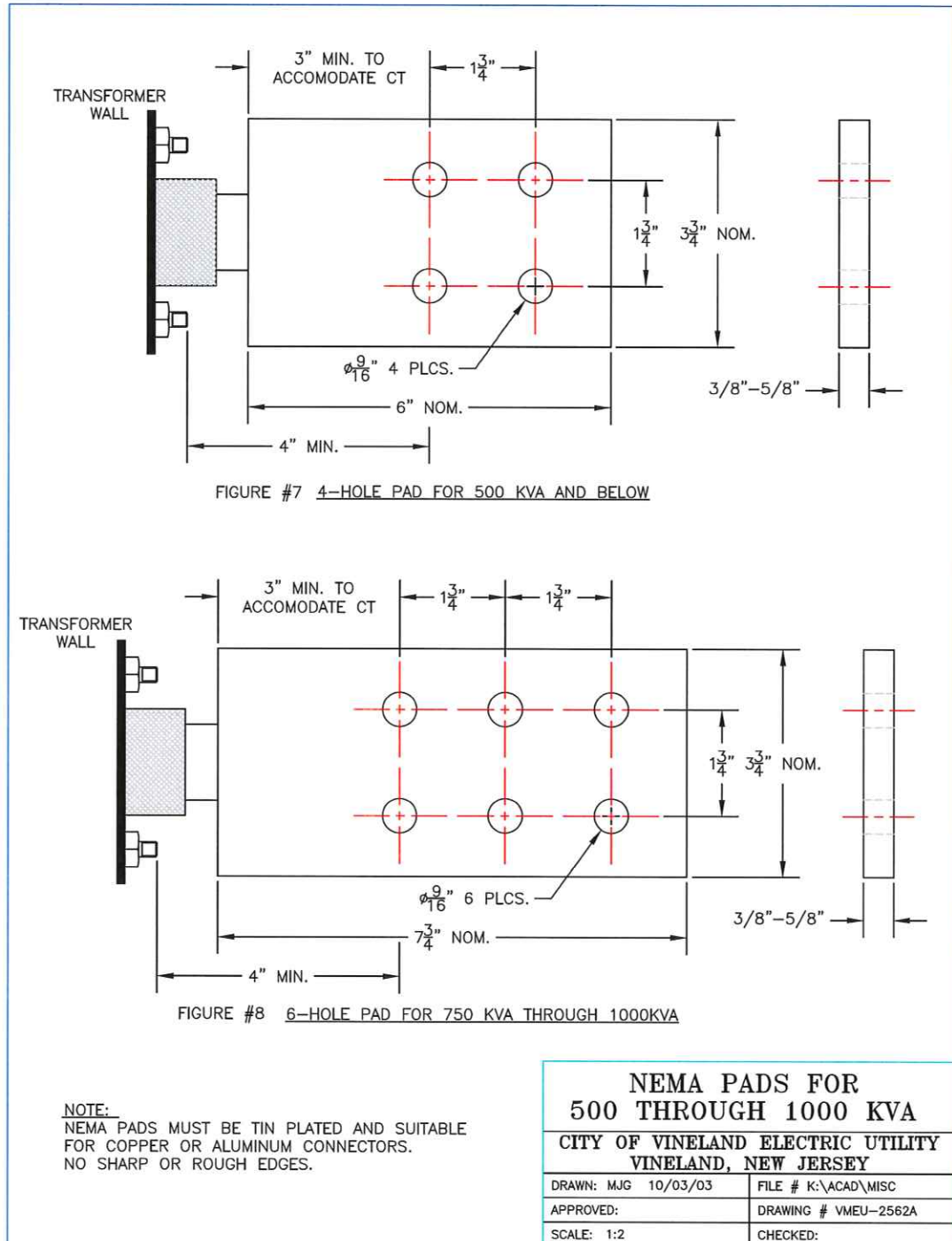

Figure # 9: Ten-Hole Pad for 1500kVA and Above

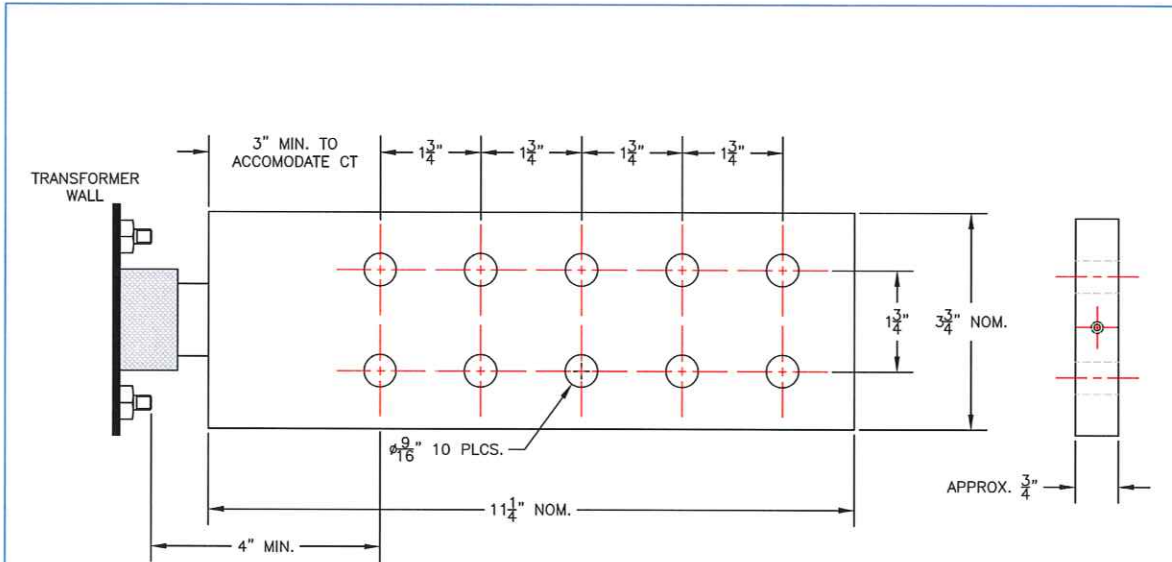

FIGURE #9 10-HOLE PAD FOR 1500 KVA AND ABOVE W/BUSHING SUPPORTS

SEE NOTE 2

NOTES:

1. NEMA PADS MUST BE TIN PLATED AND SUITABLE FOR COPPER OR ALUMINUM CONNECTORS. NO SHARP OR ROUGH EDGES.
2. TO BE FURNISHED WITH ADDITIONAL SUPPORT, DESIGNED BY THE MANUFACTURER, AT THE END FURTHEST FROM THE TANK WALL WITHOUT INTERFERING WITH THE USE OF ANY OF THE TEN HOLES.

NEMA PAD FOR 1500 KVA AND ABOVE	
CITY OF VINELAND ELECTRIC UTILITY VINELAND, NEW JERSEY	
DRAWN: MJG 10/03/03	FILE # K:\ACAD\MISC
APPROVED:	DRAWING # VMEU-2562B
SCALE: 1:2	CHECKED:

Figure # 10: Vendor Labeling Requirements

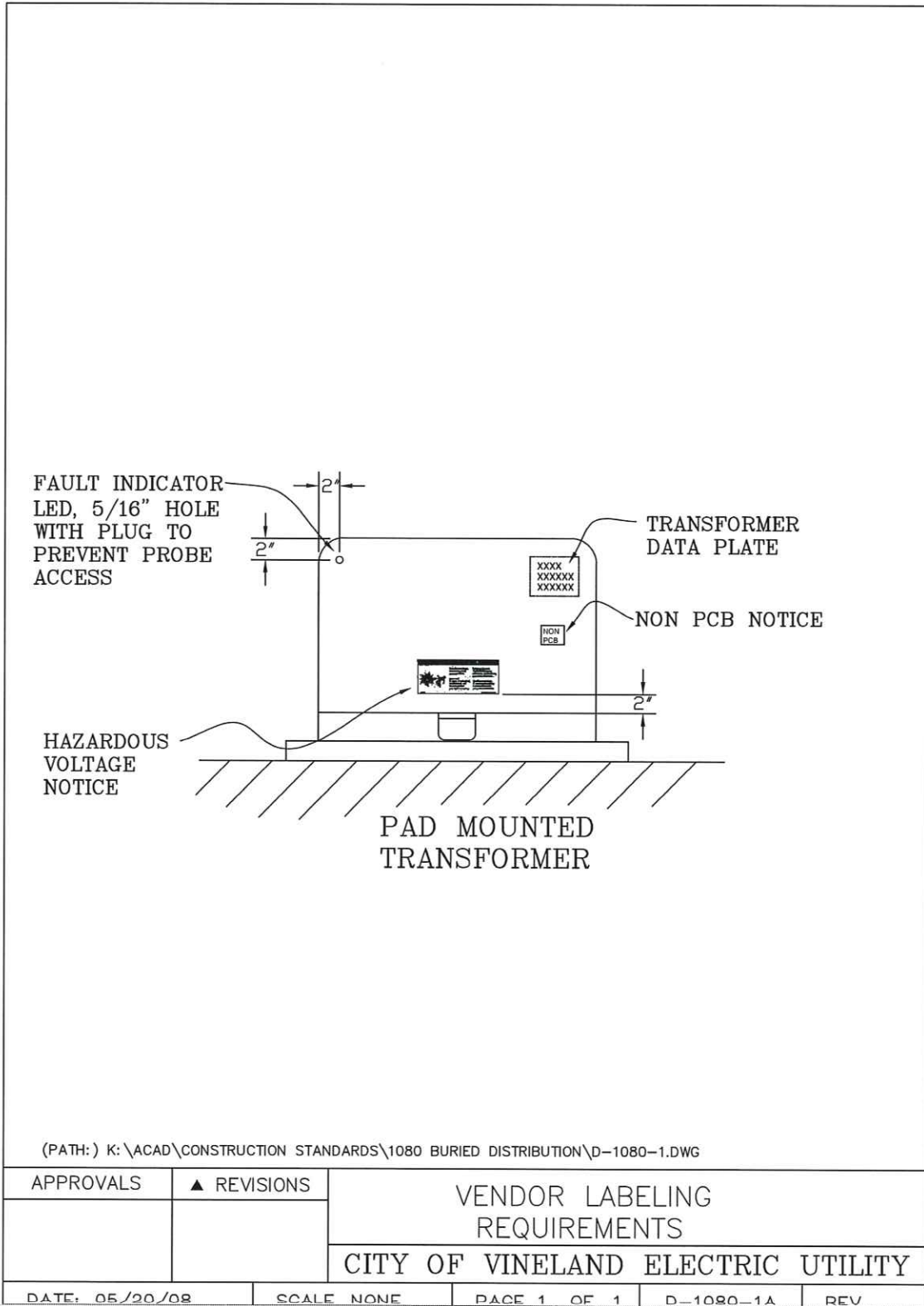

PART 5 - ATTACHMENTS

5.1. List of Attachments

Sequence	Document Name
1	Proposal Sheets

**PLEASE USE THE
FOLLOWING DOCUMENTS
WHEN SUBMITTING BOTH
YOUR ORIGINAL AND
DUPLICATE BID**

In addition to the Flash Drive, you must submit all the documents in paper form indicated after "Original and Duplicate Bid" or your Bid may be rejected.

PLEASE PRINT (LEGIBLY) OR TYPE

COV BID 2025-40

COMPANY _____

ADDRESS _____

TELEPHONE _____

WITNESS _____

The bidder shall state on the line below, if a corporation, the name of the state in which incorporated.

_____ (Contact Person Who Prepared Proposal)

_____ (Telephone Number)

_____ (Federal I.D. Number)

_____ (Email address)

BY _____ (Signature)

_____ (Name-please print or type)

_____ (Title)

DATE _____

Have you attached the required items listed on the Check List? Failure to do so may result in automatic rejection of this bid.

_____ (Fax Number)

BID CHECKLIST

**Failure by the bidder to submit with their bid all of the MANDATORY
Items that are check below shall be cause for rejection of bid.**

**ELECTRIC UTILITY DISTRIBUTION- DISTRIBUTION TRANSFORMERS
COV BID # 2025-40**

DECEMBER 3, 2025

	<u>REQUIRED WITH BID</u>	<u>INITIAL & SUBMIT</u>
1. Bid Guarantee (IN DUPLICATE) (a bid bond is not a consent of surety)	_____	_____
2. Certificate or Consent of Surety Form (IN DUPLICATE)	_____	_____
3. Statement of Ownership Disclosure (IN DUPLICATE)	_____X_____	_____
4. EEO/Affirmative Action Compliance Notice (IN DUPLICATE)	_____X_____	_____
5. Check List (IN DUPLICATE)	_____X_____	_____
6. Proposal (IN DUPLICATE)	_____X_____	_____
7. Acknowledgement of Receipt of Addenda (IN DUPLICATE)	_____X_____	_____
8. List of Subcontractors, if any. If none, state so. (IN DUPLICATE)	_____	_____

The items that are checked below shall be submitted no later than the time period indicated.

<u>Required as Conditioned</u>	<u>Item</u>	<u>Read, Initialed Shall Submit</u>
_____	Performance Bond (Due with the executed contract)	_____
_____	Labor and Material Payment Bond (Due with the executed contract)	_____

(continued on next page)

_____	Maintenance Bond (Due with the executed contract)	_____
_____	Public Works Contractor Registration Certificate(s) for the General or Prime Contractor and any Subcontractor submitted in the bid proposal with a date effective at the time the proposal is submitted (Due prior to contract award)	_____
<u> X </u>	New Jersey Business Registration Certificate (Due prior to contract award)	_____
<u> X </u>	Certificate(s) of Insurance as specified In the Bid Document (Due with executed contract)	_____
<u> X </u>	Disclosure of Investment Activities in Iran (Due at Bid Opening)	_____
<u> X </u>	Prohibited Activities In Russia or Belarus (Due at Bid Opening)	_____

The items that are checked below are to be reviewed by the bidders.

<u>Review Required</u>	<u>Item</u>	<u>Read & Initialed</u>
<u> X </u>	Americans with Disabilities Act Language	_____
<u> X </u>	General Instructions	_____
<u> X </u>	Technical Specifications	_____

THE ITEMS AND/OR FORMS INDICATED ABOVE SHALL BE REVIEWED AND/OR SUBMITTED WITH YOUR BID. THIS CHECKLIST IS PROVIDED FOR INFORMATIONAL PURPOSES ONLY. ALL REQUIRED DOCUMENTATION MAY NOT BE LISTED ABOVE AND IT SHALL BE THE RESPONSIBILITY OF THE BIDDER TO CAREFULLY REVIEW THE COMPLETE BID PACKAGE, FAMILIARIZE THEMSELVES WITH THE REQUIREMENTS OF THIS BID AND TO SUBMIT WITH THEIR BID ALL REQUIRED DOCUMENTATION.

SIGNATURE

The undersigned hereby acknowledges that they have submitted and/or reviewed the above listed requirements:

(COMPANY)

(NAME – PLEASE PRINT OR TYPE)

(SIGNATURE)

(DATE)

END OF BID CHECKLIST

INSTRUCTION TO BIDDERS

PROPOSAL SHEETS

To Bidder:

1. This Excel workbook is password protected.
2. Data may be entered only into the yellow highlighted cells on each proposal page. All other cells are locked.
Start here - This information will go to each spreadsheet.
Bidder (Vendor): _____
Contact Person: _____
Telephone: _____ *include Area Code*
Manufacturer(s) being quoted: _____
3. This is non-automated workbook. You must select the tab in which to enter data on that spreadsheet.
4. Once you have completed entering data -
 - a. Save the file with a different name, using the 'Save As' function in Excel,
 - b. There is only one proposal group. Group A is for traditional Type II dielectric
 - c. Print-out all proposal pages (or) entire workbook (*Proposals M1, 1, 2, 3, 4, and 5*). Note: *It is not necessary to print-out these instructions.*
 - d. Hand sign each page,
 - e. Return all signed pages with the Proposal package according to the instructions provided by the City's Purchasing Agent.
 - f. To avoid error upon bid evaluation, we prefer to have this completed Excel file be saved on a flash drive, and submitted with the Bidder's Proposal package.
5. If there are **ANY** issues, please contact Miguel Mercado, City of Vineland, Purchasing Agent.
Phone # (856) 794-4000 Ext 4042
or email mmercado@vinelandcity.org

GROUP A
Type II Dielectric Coolant

Proposal Micro
DISTRIBUTION TRANSFORMERS

Micro or Speciality Pole-Type, Single-phase Primary Rated

To the Purchasing Board of the City of Vineland:

The undersigned bidder declares they have read the Notice to Bidders, Instructions to Bidders, and the enclosed Specifications, and they have determined the conditions affecting the bid, and agree, if this proposal is accepted and an open-end contract awarded, to furnish and deliver transformers of this category meeting VMEU specifications, as authorized by supplemental release, for a period of one year from date of award, with option for a second year:

1. Core Type (such as amorphous steel or silicon steel): _____
2. The transformers listed below are outside are smaller than 10KVA and are not provided for in conventional IEEE standards.
3. Unit pricing shall be supplied for the listed speciality (or micro) class conventional pole-type transformers for the secondary voltages indicated.

The These transformers do NOT have provisions for secondary taps.

(Quote a Estimated
Delivery per item.)

Item	KVA	Primary Voltage	Secondary Voltage	% Imp. Min	Weighted Value	No-Load Losses, Watts *	Full-Load Losses, Watts *	Imp. % (#.##)	Weight (lbs)	Estimated Delivery (Weeks)	Unit Price (per transformer)	Total Weighted Price
MA	1	12,470GrdY/7,200	120	1.5	10							\$0.00
MB	1-1/2	12,470GrdY/7,200	120	1.5	10							\$0.00
MC	3	12,470GrdY/7,200	120	1.5	10							\$0.00
MD	5	12,470GrdY/7,200	120/240	1.75	10							\$0.00
** Total Bid = $\sum \text{Weighted Value}_i \times \text{Unit Cost}_i =$ i = MA to MC											\$0.00	

* All losses shall be accounted for, including losses due to any accessory or option. Such as secondary breakers or "MagneX"™ switches etc.

** Pro-forma only. All bids are subject to evaluation by total cost of ownership in accordance with loss evaluation formula provided and quoted terms and conditions

5. Pricing and Delivery Terms:

6 Option Year Pricing and Delivery Terms:

Bidder: 0
Contact Person: 0
Telephone: -
Manufacturer: 0

GROUP A
Type II Dielectric Coolant

Proposal 1
DISTRIBUTION TRANSFORMERS

Pole-Type, Single-phase Primary Rated

To the Purchasing Board of the City of Vineland:

The undersigned bidder declares they have read the Notice to Bidders, Instructions to Bidders, and the enclosed Specifications, and they have determined the conditions affecting the bid, and agree, if this proposal is accepted and an open-end contract awarded, to furnish and deliver transformers of this category meeting VMEU specifications, as authorized by supplemental release, for a period of one year from date of award, with option for a second year:

1. Core Type (such as amorphous steel or silicon steel): _____
2. Prices shall be supplied for conventional Pole-type transformers equipped with 2-2.5% taps above rating and 2-2.5% taps below rating, unless otherwise noted.

(Quote a Estimated
Delivery per item.)

Item	KVA	Primary Voltage	Secondary Voltage	% Imp. Min	Weighted Value	No-Load Losses, Watts *	Full-Load Losses, Watts *	Imp. % (#.##)	Weight (lbs)	Estimated Delivery (Weeks)	Unit Price (per transformer)	Total Weighted Price
1A	15	12470GrdY/7200	120/240	1.5	35							\$0.00
1B	25	12,470GrdY/7,201	120/240	1.5	75							\$0.00
1C	37.5	12,470GrdY/7,202	120/240	1.75	50							\$0.00
1D	50	12,470GrdY/7,203	120/240	1.75	30							\$0.00
1E	75	12,470GrdY/7,204	120/240	2	13							\$0.00
1F	100	12,470GrdY/7,205	120/240	2	5							\$0.00
1G	25	12,470GrdY/7,206	277	1.5	5							\$0.00
1H	37.5	12,470GrdY/7,207	277	1.5	5							\$0.00
1I	50	12,470GrdY/7,200	277	1.5	5							\$0.00
1J	75	12,470GrdY/7,200	277	1.5	5							\$0.00
1K	100	12,470GrdY/7,200	277	1.75	5							\$0.00
1L	100	12,470/21,600Y	120/240	2	3							\$0.00
1M	100	12,470/21,600Y	277	1.75	3							\$0.00
1N	100	12,470/21,600Y	240/480	1.75	3							\$0.00
1O	167	12,470/21,600Y	120/240	2	3							\$0.00
1P	167	12,470/21,600Y	277	2	3							\$0.00
1Q	167	12,470/21,600Y	240/480	2	3							\$0.00
1R	167	12,470GrdY/7,200	2400/4160Y	3.5	3							\$0.00
1S	250	12,470/21,600Y	120/240	3	3							\$0.00
1T	250	12,470/21,600Y	277	2	3							\$0.00
1U	250	12,470/21,600Y	240/480	2	3							\$0.00

** Total Bid = $\sum_{i=1A to 1P} \text{Weighted Value}_i \times \text{Unit Cost}_i =$	\$0.00
--	--------

- * All losses shall be accounted for, including losses due to any accessory or option. Such as secondary breakers or "MagneX"™ switches etc.
- ** Pro-forma only. All bids are subject to evaluation by total cost of ownership in accordance with loss evaluation formula provided and quoted terms and conditions

GROUP A
Type II Dielectric Coolant

3. Delivery Terms:

4. Option Year Pricing and Delivery Terms:

Bidder: 0 _____
Contact Person: 0 _____
Telephone: - _____
Manufacturer: 0 _____

GROUP A
Type II Dielectric Coolant

Proposal 2
DISTRIBUTION TRANSFORMERS

Pole-Type, Dual-Rated Primary Voltage

To the Purchasing Board of the City of Vineland:

The undersigned bidder declares they have read the Notice to Bidders, Instructions to Bidders, and the enclosed Specifications, and they have determined the conditions affecting the bid, and agree, if this proposal is accepted and an open-end contract awarded, to furnish and deliver transformers of this category meeting VMEU specifications, as authorized by supplemental release, for a period of one year from date of award, with option for a second year:

1. Core Type (such as amorphous steel or silicon steel): _____
2. Prices shall be supplied for conventional Pole-type transformers equipped with 2-2.5% taps above rating and 2-2.5% taps below rating, unless otherwise noted.

(Quote a Estimated
Delivery per item.)

Item	KVA	Primary Voltage	Secondary Voltage	Weighted Value	No-Load Losses, Watts *	Full-Load Losses, Watts *	Imp. % (#.##)	Weight (lbs)	Estimated Delivery (Weeks)	Unit Price (per transformer)	Total Weighted Price
2A	15	4160GrdY/2400 X 12470GrdY/7200	120/240	15							\$0.00
2B	25	4160GrdY/2400 X 12470GrdY/7200	120/240	30							\$0.00
2C	37.5	4160GrdY/2400 X 12470GrdY/7200	120/240	10							\$0.00
2D	50	4160GrdY/2400 X 12470GrdY/7200	120/240	10							\$0.00
2E	75	4160GrdY/2400 X 12470GrdY/7200	120/240	3							\$0.00
2F	100	4160GrdY/2400 X 12470GrdY/7200	120/240	3							\$0.00
2G	25	4160GrdY/2400 X 12470GrdY/7200	277	7							\$0.00
2H	37.5	4160GrdY/2400 X 12470GrdY/7200	277	7							\$0.00
2I	50	4160GrdY/2400 X 12470GrdY/7200	277	5							\$0.00
2J	75	4160GrdY/2400 X 12470GrdY/7200	277	6							\$0.00
2K	100	4160GrdY/2400 X 12470GrdY/7200	277	4							\$0.00
2L	25	2400/4160Y X 7200/12470Y	240/480	3							\$0.00
2M	37.5	2400/4160Y X 7200/12470Y	240/480	3							\$0.00
2N	75	2400/4160Y X 7200/12470Y	240/480	3							\$0.00
2O	100	2400/4160Y X 7200/12470Y	240/480	3							\$0.00

** Total Bid = $\sum_{i=2A \text{ to } 2N} \text{Weighted Value}_i \times \text{Unit Cost}_i =$	\$0.00
---	---------------

* All losses shall be accounted for, including losses due to any accessory or option. Such as secondary breakers or "MagneX"™ switches etc.

** Pro-forma only. All bids are subject to evaluation by total cost of ownership in accordance with loss evaluation formula provided and quoted terms and conditions

3. Pricing and Delivery Terms:

4. *Option Year* Pricing and Delivery Terms:

GROUP A
Type II Dielectric Coolant

Bidder: 0 _____
Contact Person: 0 _____
Telephone: - _____
Manufacturer: 0 _____

GROUP A
Type II Dielectric Coolant

Proposal 3
DISTRIBUTION TRANSFORMERS

Pad-mounted, Single-phase Primary Rated

To the Purchasing Board of the City of Vineland:

The undersigned bidder declares they have read the Notice to Bidders, Instructions to Bidders, and the enclosed Specifications, and they have determined the conditions affecting the bid, and agree, if this proposal is accepted and an open-end contract awarded, to furnish and deliver transformers of this category meeting VMEU specifications, as authorized by supplemental release, for a period of one year from date of award, with option for a second year:

1. Core Type (such as amorphous steel or silicon steel): _____
2. Prices shall be supplied for conventional Pole-type transformers equipped with 2-2.5% taps above rating and 2-2.5% taps below rating, unless otherwise noted.

(Quote a Estimated
Delivery per item.)

Item	KVA	Primary Voltage	Secondary Voltage	Weighted Value	No-Load Losses, Watts *	Full-Load Losses, Watts *	Imp. % (#.##)	Weight (lbs)	Estimated Delivery (Weeks)	Unit Price (per transformer)	Weighted Price
3A	25	12470GrdY/7200	240/120	10							\$0.00
3B	37.5	12470GrdY/7200	240/120	42							\$0.00
3C	50	12470GrdY/7200	240/120	24							\$0.00
3D	75	12470GrdY/7200	240/120	12							\$0.00
3E	100	12470GrdY/7200	240/120	4							\$0.00
3F	167	12470GrdY/7200	240/120	4							\$0.00
3G	37.5	4160GrdY/2400 X 12470GrdY/7200	240/120	1							\$0.00
3H	50	4160GrdY/2400 X 12470GrdY/7200	240/120	2							\$0.00
3I	75	4160GrdY/2400 X 12470GrdY/7200	240/120	2							\$0.00
3J	100	4160GrdY/2400 X 12470GrdY/7200	240/120	1							\$0.00

** Total Bid = \sum Weighted Value_i X Unit Cost_i = <i>i = 3A to 3J</i>	\$0.00
---	---------------

* All losses shall be accounted for, including losses due to any accessory or option. Such as secondary breakers or "MagneX"™ switches etc.

** Pro-forma only. All bids are subject to evaluation by total cost of ownership in accordance with loss evaluation formula provided and quoted terms and conditions

3. Pricing and Delivery Terms:

4. *Option Year* Pricing and Delivery Terms:

Bidder: 0 _____
 Contact Person: 0 _____
 Telephone: - _____
 Manufacturer: 0 _____

GROUP A
Type II Dielectric Coolant

Proposal 4
DISTRIBUTION TRANSFORMERS

Pad-mounted, Three-phase Primary Rated

To the Purchasing Board of the City of Vineland:

The undersigned bidder declares they have read the Notice to Bidders, Instructions to Bidders, and the enclosed Specifications, and they have determined the conditions affecting the bid, and agree, if this proposal is accepted and an open-end contract awarded, to furnish and deliver transformers of this category meeting VMEU specifications, as authorized by supplemental release, for a period of one year from date of award, with option for a second year:

1. Core Type (such as amorphous steel or silicon steel): _____
2. Prices shall be supplied for conventional Pole-type transformers equipped with 2-2.5% taps above rating and 2-2.5% taps below rating, unless otherwise noted.

(Quote a Estimated
Delivery per item.)

Item	KVA	Primary Voltage	Secondary Voltage	Weighted Value	No-Load Losses, Watts *	Full-Load Losses, Watts *	Imp. % (###)	Weight (lbs)	Estimated Delivery (Weeks)	Unit Price (per transformer)	Weighted Price
4A	150	12470GrdY/7200	208Y/120	5							\$0.00
4B	150	4160GrdY X 12470GrdY	208Y/120	1							\$0.00
4C	150	12470GrdY/7200	480Y/277	1							\$0.00
4D	225	12470GrdY/7200	208Y/120	2							\$0.00
4E	300	12470GrdY/7200	208Y/120	4							\$0.00
4F	300	4160GrdY X 12470GrdY	208Y/120	1							\$0.00
4G	300	12470GrdY/7200	480Y/277	5							\$0.00
4H	300	4160GrdY X 12470GrdY	480Y/277	1							\$0.00
4I	500	12470GrdY/7200	208Y/120	1							\$0.00
4J	500	12470GrdY/7200	480Y/277	3							\$0.00
4K	750	12470GrdY/7200	480Y/277	3							\$0.00
4L	1000	12470GrdY/7200	480Y/277	3							\$0.00
4M	1500	12470GrdY/7200	480Y/277	2							\$0.00
4N	2000	12470 Delta	480Y/277	1							\$0.00
4O	2500	12470 Delta	480Y/277	1							\$0.00

** Total Bid = $\sum \text{Weighted Value}_i \times \text{Unit Cost}_i =$ <i>i = 4A to 4NB</i>	\$0.00
---	---------------

* All losses shall be accounted for, including losses due to any accessory or option. Such as secondary breakers or "MagneX"™ switches etc.
 ** Pro-forma only. All bids are subject to evaluation by total cost of ownership in accordance with loss evaluation formula provided and quoted terms and conditions

3. Pricing and Delivery Terms:

4. **Option Year** Pricing and Delivery Terms:

Bidder: 0 _____
 Contact Person: 0 _____
 Telephone: - _____
 Manufacturer: 0 _____

GROUP A Type II Dielectric Coolant

Proposal 5

1. Are quoted transformer unit prices firm and not subject to escalation charges?
 Check - YES _____ or NO _____

Refer to Technical Specification - Section 1.15

2. If unit prices are subject to escalation, the table below must be filled out completely.

			Please make to 2 decimal places	Please make to 2 decimal places	Please make to 4 decimal places
Commodity Index	Base Reference Index Cost/Value	Current Commodity (Bid Basis)	% Change from Base Index (###.##)	Weighting Factor (Material Cost as a % of Price) (###.##)	Weighted % Change (##.####)
Carbon Steel					
Core Steel					
Copper					
Aluminum					
Mineral Oil (dielectric fluid)					
All other materials, labor, transporation, overhead, and margin			0.00		
Transformer Surcharge Index				0.00%	0.0000

The sum of the above 6 numbers = 100.00%

3. Each bidder shall provide the commodity index and description.

Commodity Index	Description
Carbon Steel	
Core Steel	
Copper	
Aluminum	
Mineral Oil (dielectric fluid)	

4. The Bidder has read section I, paragraph N, entitled "Proposals".
 Check - YES _____ or NO _____
5. The Bidder has read and understands section I, paragraph P, entitled "Pricing Terms & Conditions".
 Check - YES _____ or NO _____
6. The Bidder has read section I, paragraph R, which relate to "Exceptions to Bid Specifications".
 Check - YES _____ or NO _____

GROUP A
Type II Dielectric Coolant

7. The Bidder has read section I, paragraph S, entitled "Contract Period".
Check - YES _____ or NO _____

8. Delivery Terms for first year:

9. **Option Year** Pricing and Delivery Terms:

Bidder: 0 _____
Contact Person: 0 _____
Telephone: - _____
Manufacturer: 0 _____

STATEMENT OF OWNERSHIP DISCLOSURE

N.J.S.A. 52:25-24.2 (P.L. 1977, c.33, as amended by P.L. 2016, c.43)

This statement shall be completed, certified to, and included with all bid and proposal submissions. Failure to submit the required information is cause for automatic rejection of the bid or proposal.

Name of Organization: _____

Organization Address: _____

Part I

Check the box that represents the type of business organization:

- Sole Proprietorship (skip Parts II and III, execute certification in Part IV)
- Non-Profit Corporation (skip Parts II and III, execute certification in Part IV)
- For-Profit Corporation (any type)
- Limited Liability Company (LLC)
- Partnership
- Limited Partnership
- Limited Liability Partnership (LLP)
- Other (be specific): _____

Part II

The list below contains the names and addresses of all stockholders in the corporation who own 10 percent or more of its stock, of any class, or of all individual partners in the partnership who own a 10 percent or greater interest therein, or of all members in the limited liability company who own a 10 percent or greater interest therein, as the case may be. **(COMPLETE THE LIST BELOW IN THIS SECTION)**

OR

No one stockholder in the corporation owns 10 percent or more of its stock, of any class, or no individual partner in the partnership owns a 10 percent or greater interest therein, or no member in the limited liability company owns a 10 percent or greater interest therein, as the case may be. **(SKIP TO PART IV)**

(Please attach additional sheets if more space is needed):

Name of Individual or Business Entity	Address

Part III

DISCLOSURE OF 10% OR GREATER OWNERSHIP IN THE STOCKHOLDERS, PARTNERS OR LLC MEMBERS LISTED IN PART II

If a bidder has a direct or indirect parent entity which is publicly traded, and any person holds a 10 percent or greater beneficial interest in the publicly traded parent entity as of the last annual federal Security and Exchange Commission (SEC) or foreign equivalent filing, ownership disclosure can be met by providing links to the website(s) containing the last annual filing(s) with the federal Securities and Exchange Commission (or foreign equivalent) that contain the name and address of each person holding a 10% or greater beneficial interest in the publicly traded parent entity, along with the relevant page numbers of the filing(s) that contain the information on each such person. **Attach additional sheets if more space is needed.**

Website (URL) containing the last annual SEC (or foreign equivalent) filing	Page #'s

Please list the names and addresses of each stockholder, partner or member owning a 10 percent or greater interest in any corresponding corporation, partnership and/or limited liability company (LLC) listed in Part II **other than for any publicly traded parent entities referenced above.** The disclosure shall be continued until names and addresses of every noncorporate stockholder, and individual partner, and member exceeding the 10 percent ownership criteria established pursuant to N.J.S.A. 52:25-24.2 has been listed. **Attach additional sheets if more space is needed.**

Stockholder/Partner/Member and Corresponding Entity Listed in Part II	Address

**Part IV
Certification**

I, being duly sworn upon my oath, hereby represent that the foregoing information and any attachments thereto to the best of my knowledge are true and complete. I acknowledge: that I am authorized to execute this certification on behalf of the bidder/proposer; that the _____ is relying on the information contained herein and that I am under a continuing obligation from the date of this certification through the completion of any contracts with _____ to notify the _____ in writing of any changes to the information contained herein; that I am aware that it is a criminal offense to make a false statement or misrepresentation in this certification, and if I do so, I am subject to criminal prosecution under the law and that it will constitute a material breach of my agreement(s) with the, permitting the _____ to declare any contract(s) resulting from this certification void and unenforceable.

Full Name (Print):		Title:	
Signature:		Date:	

**AFFIRMATIVE ACTION COMPLIANCE NOTICE
N.J.S.A. 10:5-31 and N.J.A.C. 17:27**

**GOODS AND SERVICES CONTRACTS
(INCLUDING PROFESSIONAL SERVICES)**

This form is a summary of the successful bidder's requirement to comply with the requirements of N.J.S.A. 10:5-31 and N.J.A.C. 17:27-1 et seq.

The successful bidder shall submit to the public agency, after notification of award but prior to execution of this contract, one of the following three documents as forms of evidence:

(a) A photocopy of a valid letter that the contractor is operating under an existing Federally approved or sanctioned affirmative action program (good for one year from the date of the letter);

OR

(b) A photocopy of a Certificate of Employee Information Report approval, issued in accordance with N.J.A.C. 17:27-4;

OR

(c) A photocopy of an Employee Information Report (Form AA302) provided by the Division and distributed to the public agency to be completed by the contractor in accordance with N.J.A.C. 17:27-4.

The successful vendor may obtain the Affirmative Action Employee Information Report (AA302) from the contracting unit during normal business hours.

The successful vendor(s) must submit the copies of the AA302 Report to the Division of Contract Compliance and Equal Employment Opportunity in Public Contracts (Division). The Public Agency copy is submitted to the public agency, and the vendor copy is retained by the vendor.

The undersigned vendor certifies that he/she is aware of the commitment to comply with the requirements of N.J.S.A. 10:5-31 and N.J.A.C. 17:27.1 et seq. and agrees to furnish the required forms of evidence.

The undersigned vendor further understands that his/her bid shall be rejected as non-responsive if said contractor fails to comply with the requirements of N.J.S.A. 10:5-31 and N.J.A.C. 17:27-1 et seq.

COMPANY: _____ SIGNATURE: _____

PRINT NAME: _____ TITLE: _____

DATE: _____

**FAILURE BY BIDDER TO COMPLETE AND RETURN THIS NOTICE WITH THEIR BID SUBMISSION
SHALL BE CAUSE FOR THEIR BID TO BE REJECTED AS NON-RESPONSIVE**

**CITY OF VINELAND
ACKNOWLEDGMENT OF RECEIPT OF ADDENDA**

Pursuant to N.J.S.A. 40A:11-23.1a, the undersigned bidder hereby acknowledges receipt of the following notices, revisions, or addenda to the bid advertisement, specifications or bid documents. By indicating date of receipt, bidder acknowledges the submitted bid takes into account the provisions of notice, revision or addendum. Note that the local unit's record of notice to bidders shall take precedence and that failure to include provisions of changes in a bid proposal may be subject for rejection of the bid.

The undersigned Bidder hereby acknowledges receipt of the following Addenda:

Addendum Number	Dated	Acknowledge Receipt (initial)
_____	_____	_____
_____	_____	_____
_____	_____	_____
_____	_____	_____

No addenda were received:

Acknowledged for: _____
(Name of Bidder)

By: _____
(Signature of Authorized Representative)

Name: _____
(Print or Type)

Title: _____

Date: _____



DISCLOSURE OF INVESTMENT ACTIVITIES IN IRAN FORM

STATE OF NEW JERSEY
DEPARTMENT OF THE TREASURY - DIVISION OF PURCHASE AND PROPERTY
33 WEST STATE STREET, P.O. BOX 230 TRENTON, NEW JERSEY 08625-0230

BID SOLICITATION # AND TITLE: _____

VENDOR NAME: _____

Pursuant to N.J.S.A. 52:32-57, et seq. (P.L. 2012, c.25 and P.L. 2021, c.4) any person or entity that submits a bid or proposal or otherwise proposes to enter into or renew a contract must certify that neither the person nor entity, nor any of its parents, subsidiaries, or affiliates, is identified on the New Jersey Department of the Treasury's Chapter 25 List as a person or entity engaged in investment activities in Iran. The Chapter 25 list is found on the Division's website at <https://www.state.nj.us/treasury/purchase/pdf/Chapter25List.pdf>. Vendors/Bidders must review this list prior to completing the below certification. If the Director of the Division of Purchase and Property finds a person or entity to be in violation of the law, s/he shall take action as may be appropriate and provided by law, rule or contract, including but not limited to, imposing sanctions, seeking compliance, recovering damages, declaring the party in default and seeking debarment or suspension of the party.

CHECK THE APPROPRIATE BOX

I certify, pursuant to N.J.S.A. 52:32-57, et seq. (P.L. 2012, c.25 and P.L. 2021, c.4), that neither the Vendor/Bidder listed above nor any of its parents, subsidiaries, or affiliates is listed on the New Jersey Department of the Treasury's Chapter 25 List of entities determined to be engaged in prohibited activities in Iran.

OR

I am unable to certify as above because the Vendor/Bidder and/or one or more of its parents, subsidiaries, or affiliates is listed on the New Jersey Department of the Treasury's Chapter 25 List. I will provide a detailed, accurate and precise description of the activities of the Vendor/Bidder, or one of its parents, subsidiaries or affiliates, has engaged in regarding investment activities in Iran by completing the information requested below.

Entity Engaged in Investment Activities	_____
Relationship to Vendor/ Bidder	_____
Description of Activities	_____

Duration of Engagement	_____
Anticipated Cessation Date	_____

**Attach Additional Sheets If Necessary.*

CERTIFICATION

I, the undersigned, certify that I am authorized to execute this certification on behalf of the Vendor, that the foregoing information and any attachments hereto, to the best of my knowledge are true and complete. I acknowledge that the State of New Jersey is relying on the information contained herein, and that the Vendor is under a continuing obligation from the date of this certification through the completion of any contract(s) with the State to notify the State in writing of any changes to the information contained herein; that I am aware that it is a criminal offense to make a false statement or misrepresentation in this certification. If I do so, I may be subject to criminal prosecution under the law, and it will constitute a material breach of my contract(s) with the State, permitting the State to declare any contract(s) resulting from this certification void and unenforceable.

Signature

Date

Print Name and Title



CERTIFICATION OF NON-INVOLVEMENT IN PROHIBITED ACTIVITIES IN RUSSIA OR BELARUS

Pursuant to N.J.S.A. 52:32-60.1, et seq. ([L. 2022, c. 3](#)) any person or entity (hereinafter "Vendor") that seeks to enter into or renew a contract with a State agency for the provision of goods or services, or the purchase of bonds or other obligations, must complete the certification below indicating whether or not the Vendor is identified on the Office of Foreign Assets Control (OFAC) Specially Designated Nationals and Blocked Persons list, available here: <https://sanctionssearch.ofac.treas.gov/>. If the Department of the Treasury finds that a Vendor has made a certification in violation of the law, it shall take any action as may be appropriate and provided by law, rule or contract, including but not limited to, imposing sanctions, seeking compliance, recovering damages, declaring the party in default and seeking debarment or suspension of the party.

I, the undersigned, certify that I have read the definition of "Vendor" below, and have reviewed the Office of Foreign Assets Control (OFAC) Specially Designated Nationals and Blocked Persons list, and having done so certify:

(Check the Appropriate Box)

A. That the Vendor is not identified on the [OFAC Specially Designated Nationals and Blocked Persons list on account of activity related to Russia and/or Belarus](#).

OR

B. That I am unable to certify as to "A" above, because the Vendor is identified on the [OFAC Specially Designated Nationals and Blocked Persons list on account of activity related to Russia and/or Belarus](#).

OR

C. That I am unable to certify as to "A" above, because the Vendor is identified on the [OFAC Specially Designated Nationals and Blocked Persons list](#). However, the Vendor is engaged in activity related to Russia and/or Belarus consistent with federal law, regulation, license or exemption. A detailed description of how the Vendor's activity related to Russia and/or Belarus is consistent with federal law is set forth below.

(Attach Additional Sheets If Necessary.)

Signature of Vendor's Authorized Representative

Date

Print Name and Title of Vendor's Authorized Representative

Vendor's FEIN

Vendor's Name

Vendor's Phone Number

Vendor's Address (Street Address)

Vendor's Fax Number

Vendor's Address (City/State/Zip Code)

Vendor's Email Address

ⁱ Vendor means: (1) A natural person, corporation, company, limited partnership, limited liability partnership, limited liability company, business association, sole proprietorship, joint venture, partnership, society, trust, or any other nongovernmental entity, organization, or group; (2) Any governmental entity or instrumentality of a government, including a multilateral development institution, as defined in Section 1701(c)(3) of the International Financial Institutions Act, 22 U.S.C. 262r(c)(3); or (3) Any parent, successor, subunit, direct or indirect subsidiary, or any entity under common ownership or control with, any entity described in paragraph (1) or (2).

**PLEASE USE THE
FOLLOWING DOCUMENTS
WHEN SUBMITTING BOTH
YOUR ORIGINAL AND
DUPLICATE BID**

In addition to the Flash Drive, you must submit all the documents in paper form indicated after "Original and Duplicate Bid" or your Bid may be rejected.

PLEASE PRINT (LEGIBLY) OR TYPE

COV BID 2025-40

COMPANY_____

ADDRESS_____

TELEPHONE_____

WITNESS_____

The bidder shall state on the line below, if a corporation, the name of the state in which incorporated.

BY_____

(Signature)

(Title)

DATE_____

Have you attached the required items listed on the Check List? Failure to do so may result in automatic rejection of this bid.

(Fax Number)

BID CHECKLIST

**Failure by the bidder to submit with their bid all of the MANDATORY
Items that are check below shall be cause for rejection of bid.**

**ELECTRIC UTILITY DISTRIBUTION- DISTRIBUTION TRANSFORMERS
COV BID # 2025-40**

DECEMBER 3, 2025

	<u>REQUIRED WITH BID</u>	<u>INITIAL & SUBMIT</u>
1. Bid Guarantee (IN DUPLICATE) (a bid bond is not a consent of surety)	_____	_____
2. Certificate or Consent of Surety Form (IN DUPLICATE)	_____	_____
3. Statement of Ownership Disclosure (IN DUPLICATE)	_____X_____	_____
4. EEO/Affirmative Action Compliance Notice (IN DUPLICATE)	_____X_____	_____
5. Check List (IN DUPLICATE)	_____X_____	_____
6. Proposal (IN DUPLICATE)	_____X_____	_____
7. Acknowledgement of Receipt of Addenda (IN DUPLICATE)	_____X_____	_____
8. List of Subcontractors, if any. If none, state so. (IN DUPLICATE)	_____	_____

The items that are checked below shall be submitted no later than the time period indicated.

<u>Required as Conditioned</u>	<u>Item</u>	<u>Read, Initialed Shall Submit</u>
_____	Performance Bond (Due with the executed contract)	_____
_____	Labor and Material Payment Bond (Due with the executed contract)	_____

(continued on next page)

_____	Maintenance Bond (Due with the executed contract)	_____
_____	Public Works Contractor Registration Certificate(s) for the General or Prime Contractor and any Subcontractor submitted in the bid proposal with a date effective at the time the proposal is submitted (Due prior to contract award)	_____
<u> X </u>	New Jersey Business Registration Certificate (Due prior to contract award)	_____
<u> X </u>	Certificate(s) of Insurance as specified In the Bid Document (Due with executed contract)	_____
<u> X </u>	Disclosure of Investment Activities in Iran (Due at Bid Opening)	_____
<u> X </u>	Prohibited Activities In Russia or Belarus (Due at Bid Opening)	_____

The items that are checked below are to be reviewed by the bidders.

<u>Review Required</u>	<u>Item</u>	<u>Read & Initialed</u>
<u> X </u>	Americans with Disabilities Act Language	_____
<u> X </u>	General Instructions	_____
<u> X </u>	Technical Specifications	_____

THE ITEMS AND/OR FORMS INDICATED ABOVE SHALL BE REVIEWED AND/OR SUBMITTED WITH YOUR BID. THIS CHECKLIST IS PROVIDED FOR INFORMATIONAL PURPOSES ONLY. ALL REQUIRED DOCUMENTATION MAY NOT BE LISTED ABOVE AND IT SHALL BE THE RESPONSIBILITY OF THE BIDDER TO CAREFULLY REVIEW THE COMPLETE BID PACKAGE, FAMILIARIZE THEMSELVES WITH THE REQUIREMENTS OF THIS BID AND TO SUBMIT WITH THEIR BID ALL REQUIRED DOCUMENTATION.

SIGNATURE

The undersigned hereby acknowledges that they have submitted and/or reviewed the above listed requirements:

(COMPANY)

(NAME – PLEASE PRINT OR TYPE)

(SIGNATURE)

(DATE)

END OF BID CHECKLIST

INSTRUCTION TO BIDDERS

PROPOSAL SHEETS

To Bidder:

1. This Excel workbook is password protected.
2. Data may be entered only into the yellow highlighted cells on each proposal page. All other cells are locked.
Start here - This information will go to each spreadsheet.
Bidder (Vendor): _____
Contact Person: _____
Telephone: _____ *include Area Code*
Manufacturer(s) being quoted: _____
3. This is non-automated workbook. You must select the tab in which to enter data on that spreadsheet.
4. Once you have completed entering data -
 - a. Save the file with a different name, using the 'Save As' function in Excel,
 - b. There is only one proposal group. Group A is for traditional Type II dielectric
 - c. Print-out all proposal pages (or) entire workbook (*Proposals M1, 1, 2, 3, 4, and 5*). Note: *It is not necessary to print-out these instructions.*
 - d. Hand sign each page,
 - e. Return all signed pages with the Proposal package according to the instructions provided by the City's Purchasing Agent.
 - f. To avoid error upon bid evaluation, we prefer to have this completed Excel file be saved on a flash drive, and submitted with the Bidder's Proposal package.
5. If there are **ANY** issues, please contact Miguel Mercado, City of Vineland, Purchasing Agent.
Phone # (856) 794-4000 Ext 4042
or email mmercado@vinelandcity.org

GROUP A
Type II Dielectric Coolant

Proposal Micro
DISTRIBUTION TRANSFORMERS

Micro or Speciality Pole-Type, Single-phase Primary Rated

To the Purchasing Board of the City of Vineland:

The undersigned bidder declares they have read the Notice to Bidders, Instructions to Bidders, and the enclosed Specifications, and they have determined the conditions affecting the bid, and agree, if this proposal is accepted and an open-end contract awarded, to furnish and deliver transformers of this category meeting VMEU specifications, as authorized by supplemental release, for a period of one year from date of award, with option for a second year:

1. Core Type (such as amorphous steel or silicon steel): _____
2. The transformers listed below are outside are smaller than 10KVA and are not provided for in conventional IEEE standards.
3. Unit pricing shall be supplied for the listed specialty (or micro) class conventional pole-type transformers for the secondary voltages indicated.

The These transformers do NOT have provisions for secondary taps.

(Quote a Estimated
Delivery per item.)

Item	KVA	Primary Voltage	Secondary Voltage	% Imp. Min	Weighted Value	No-Load Losses, Watts *	Full-Load Losses, Watts *	Imp. % (#.##)	Weight (lbs)	Estimated Delivery (Weeks)	Unit Price (per transformer)	Total Weighted Price
MA	1	12,470GrdY/7,200	120	1.5	10							\$0.00
MB	1-1/2	12,470GrdY/7,200	120	1.5	10							\$0.00
MC	3	12,470GrdY/7,200	120	1.5	10							\$0.00
MD	5	12,470GrdY/7,200	120/240	1.75	10							\$0.00

** Total Bid = $\sum_{i=MA\ to\ MC} \text{Weighted Value}_i \times \text{Unit Cost}_i =$	\$0.00
--	---------------

* All losses shall be accounted for, including losses due to any accessory or option. Such as secondary breakers or "MagneX"™ switches etc.

** Pro-forma only. All bids are subject to evaluation by total cost of ownership in accordance with loss evaluation formula provided and quoted terms and conditions

5. Pricing and Delivery Terms:

6 Option Year Pricing and Delivery Terms:

Bidder: 0
Contact Person: 0
Telephone: -
Manufacturer: 0

GROUP A
Type II Dielectric Coolant

Proposal 1
DISTRIBUTION TRANSFORMERS

Pole-Type, Single-phase Primary Rated

To the Purchasing Board of the City of Vineland:

The undersigned bidder declares they have read the Notice to Bidders, Instructions to Bidders, and the enclosed Specifications, and they have determined the conditions affecting the bid, and agree, if this proposal is accepted and an open-end contract awarded, to furnish and deliver transformers of this category meeting VMEU specifications, as authorized by supplemental release, for a period of one year from date of award, with option for a second year:

1. Core Type (such as amorphous steel or silicon steel): _____
2. Prices shall be supplied for conventional Pole-type transformers equipped with 2-2.5% taps above rating and 2-2.5% taps below rating, unless otherwise noted.

(Quote a Estimated
Delivery per item.)

Item	KVA	Primary Voltage	Secondary Voltage	% Imp. Min	Weighted Value	No-Load Losses, Watts *	Full-Load Losses, Watts *	Imp. % (#.##)	Weight (lbs)	Estimated Delivery (Weeks)	Unit Price (per transformer)	Total Weighted Price
1A	15	12470GrdY/7200	120/240	1.5	35							\$0.00
1B	25	12,470GrdY/7,201	120/240	1.5	75							\$0.00
1C	37.5	12,470GrdY/7,202	120/240	1.75	50							\$0.00
1D	50	12,470GrdY/7,203	120/240	1.75	30							\$0.00
1E	75	12,470GrdY/7,204	120/240	2	13							\$0.00
1F	100	12,470GrdY/7,205	120/240	2	5							\$0.00
1G	25	12,470GrdY/7,206	277	1.5	5							\$0.00
1H	37.5	12,470GrdY/7,207	277	1.5	5							\$0.00
1I	50	12,470GrdY/7,200	277	1.5	5							\$0.00
1J	75	12,470GrdY/7,200	277	1.5	5							\$0.00
1K	100	12,470GrdY/7,200	277	1.75	5							\$0.00
1L	100	12,470/21,600Y	120/240	2	3							\$0.00
1M	100	12,470/21,600Y	277	1.75	3							\$0.00
1N	100	12,470/21,600Y	240/480	1.75	3							\$0.00
1O	167	12,470/21,600Y	120/240	2	3							\$0.00
1P	167	12,470/21,600Y	277	2	3							\$0.00
1Q	167	12,470/21,600Y	240/480	2	3							\$0.00
1R	167	12,470GrdY/7,200	2400/4160Y	3.5	3							\$0.00
1S	250	12,470/21,600Y	120/240	3	3							\$0.00
1T	250	12,470/21,600Y	277	2	3							\$0.00
1U	250	12,470/21,600Y	240/480	2	3							\$0.00

** Total Bid = $\sum_{i=1A \text{ to } 1P} \text{Weighted Value}_i \times \text{Unit Cost}_i =$	\$0.00
---	---------------

* All losses shall be accounted for, including losses due to any accessory or option. Such as secondary breakers or "MagneX"™ switches etc.
 ** Pro-forma only. All bids are subject to evaluation by total cost of ownership in accordance with loss evaluation formula provided and quoted terms and conditions

GROUP A
Type II Dielectric Coolant

3. **Delivery Terms:**

4. **Option Year Pricing and Delivery Terms:**

Bidder: 0 _____
Contact Person: 0 _____
Telephone: - _____
Manufacturer: 0 _____

GROUP A
Type II Dielectric Coolant

Proposal 2
DISTRIBUTION TRANSFORMERS

Pole-Type, Dual-Rated Primary Voltage

To the Purchasing Board of the City of Vineland:

The undersigned bidder declares they have read the Notice to Bidders, Instructions to Bidders, and the enclosed Specifications, and they have determined the conditions affecting the bid, and agree, if this proposal is accepted and an open-end contract awarded, to furnish and deliver transformers of this category meeting VMEU specifications, as authorized by supplemental release, for a period of one year from date of award, with option for a second year:

1. Core Type (such as amorphous steel or silicon steel): _____
2. Prices shall be supplied for conventional Pole-type transformers equipped with 2-2.5% taps above rating and 2-2.5% taps below rating, unless otherwise noted.

(Quote a Estimated
Delivery per Item.)

Item	KVA	Primary Voltage	Secondary Voltage	Weighted Value	No-Load Losses, Watts *	Full-Load Losses, Watts *	Imp. % (#.##)	Weight (lbs)	Estimated Delivery (Weeks)	Unit Price (per transformer)	Total Weighted Price
2A	15	4160GrdY/2400 X 12470GrdY/7200	120/240	15							\$0.00
2B	25	4160GrdY/2400 X 12470GrdY/7200	120/240	30							\$0.00
2C	37.5	4160GrdY/2400 X 12470GrdY/7200	120/240	10							\$0.00
2D	50	4160GrdY/2400 X 12470GrdY/7200	120/240	10							\$0.00
2E	75	4160GrdY/2400 X 12470GrdY/7200	120/240	3							\$0.00
2F	100	4160GrdY/2400 X 12470GrdY/7200	120/240	3							\$0.00
2G	25	4160GrdY/2400 X 12470GrdY/7200	277	7							\$0.00
2H	37.5	4160GrdY/2400 X 12470GrdY/7200	277	7							\$0.00
2I	50	4160GrdY/2400 X 12470GrdY/7200	277	5							\$0.00
2J	75	4160GrdY/2400 X 12470GrdY/7200	277	6							\$0.00
2K	100	4160GrdY/2400 X 12470GrdY/7200	277	4							\$0.00
2L	25	2400/4160Y X 7200/12470Y	240/480	3							\$0.00
2M	37.5	2400/4160Y X 7200/12470Y	240/480	3							\$0.00
2N	75	2400/4160Y X 7200/12470Y	240/480	3							\$0.00
2O	100	2400/4160Y X 7200/12470Y	240/480	3							\$0.00

** Total Bid = $\sum_{i=2A \text{ to } 2N} \text{Weighted Value}_i \times \text{Unit Cost}_i =$	\$0.00
---	---------------

* All losses shall be accounted for, including losses due to any accessory or option. Such as secondary breakers or "MagneX"™ switches etc.

** Pro-forma only. All bids are subject to evaluation by total cost of ownership in accordance with loss evaluation formula provided and quoted terms and conditions

3. Pricing and Delivery Terms:

4. **Option Year** Pricing and Delivery Terms:

GROUP A
Type II Dielectric Coolant

Bidder: 0 _____
Contact Person: 0 _____
Telephone: - _____
Manufacturer: 0 _____

GROUP A
Type II Dielectric Coolant

Proposal 3
DISTRIBUTION TRANSFORMERS

Pad-mounted, Single-phase Primary Rated

To the Purchasing Board of the City of Vineland:

The undersigned bidder declares they have read the Notice to Bidders, Instructions to Bidders, and the enclosed Specifications, and they have determined the conditions affecting the bid, and agree, if this proposal is accepted and an open-end contract awarded, to furnish and deliver transformers of this category meeting VMEU specifications, as authorized by supplemental release, for a period of one year from date of award, with option for a second year:

1. Core Type (such as amorphous steel or silicon steel): _____
2. Prices shall be supplied for conventional Pole-type transformers equipped with 2-2.5% taps above rating and 2-2.5% taps below rating, unless otherwise noted.

(Quote a Estimated
Delivery per item.)

Item	KVA	Primary Voltage	Secondary Voltage	Weighted Value	No-Load Losses, Watts *	Full-Load Losses, Watts *	Imp. % (#.##)	Weight (lbs)	Estimated Delivery (Weeks)	Unit Price (per transformer)	Weighted Price
3A	25	12470GrdY/7200	240/120	10							\$0.00
3B	37.5	12470GrdY/7200	240/120	42							\$0.00
3C	50	12470GrdY/7200	240/120	24							\$0.00
3D	75	12470GrdY/7200	240/120	12							\$0.00
3E	100	12470GrdY/7200	240/120	4							\$0.00
3F	167	12470GrdY/7200	240/120	4							\$0.00
3G	37.5	4160GrdY/2400 X 12470GrdY/7200	240/120	1							\$0.00
3H	50	4160GrdY/2400 X 12470GrdY/7200	240/120	2							\$0.00
3I	75	4160GrdY/2400 X 12470GrdY/7200	240/120	2							\$0.00
3J	100	4160GrdY/2400 X 12470GrdY/7200	240/120	1							\$0.00

** Total Bid = $\sum_{i=3A \text{ to } 3I} \text{Weighted Value}_i \times \text{Unit Cost}_i =$	\$0.00
---	---------------

* All losses shall be accounted for, including losses due to any accessory or option. Such as secondary breakers or "MagneX"™ switches etc.

** Pro-forma only. All bids are subject to evaluation by total cost of ownership in accordance with loss evaluation formula provided and quoted terms and conditions

3. Pricing and Delivery Terms:

4. **Option Year** Pricing and Delivery Terms:

Bidder: 0 _____
 Contact Person: 0 _____
 Telephone: - _____
 Manufacturer: 0 _____

GROUP A
Type II Dielectric Coolant

Proposal 4
DISTRIBUTION TRANSFORMERS

Pad-mounted, Three-phase Primary Rated

To the Purchasing Board of the City of Vineland:

The undersigned bidder declares they have read the Notice to Bidders, Instructions to Bidders, and the enclosed Specifications, and they have determined the conditions affecting the bid, and agree, if this proposal is accepted and an open-end contract awarded, to furnish and deliver transformers of this category meeting VMEU specifications, as authorized by supplemental release, for a period of one year from date of award, with option for a second year:

1. Core Type (such as amorphous steel or silicon steel): _____
2. Prices shall be supplied for conventional Pole-type transformers equipped with 2-2.5% taps above rating and 2-2.5% taps below rating, unless otherwise noted.

(Quote a Estimated
Delivery per item.)

Item	KVA	Primary Voltage	Secondary Voltage	Weighted Value	No-Load Losses, Watts *	Full-Load Losses, Watts *	Imp. % (#.##)	Weight (lbs)	Estimated Delivery (Weeks)	Unit Price (per transformer)	Weighted Price
4A	150	12470GrdY/7200	208Y/120	5							\$0.00
4B	150	4160GrdY X 12470GrdY	208Y/120	1							\$0.00
4C	150	12470GrdY/7200	480Y/277	1							\$0.00
4D	225	12470GrdY/7200	208Y/120	2							\$0.00
4E	300	12470GrdY/7200	208Y/120	4							\$0.00
4F	300	4160GrdY X 12470GrdY	208Y/120	1							\$0.00
4G	300	12470GrdY/7200	480Y/277	5							\$0.00
4H	300	4160GrdY X 12470GrdY	480Y/277	1							\$0.00
4I	500	12470GrdY/7200	208Y/120	1							\$0.00
4J	500	12470GrdY/7200	480Y/277	3							\$0.00
4K	750	12470GrdY/7200	480Y/277	3							\$0.00
4L	1000	12470GrdY/7200	480Y/277	3							\$0.00
4M	1500	12470GrdY/7200	480Y/277	2							\$0.00
4N	2000	12470 Delta	480Y/277	1							\$0.00
4O	2500	12470 Delta	480Y/277	1							\$0.00
** Total Bid = $\sum \text{Weighted Value}_i \times \text{Unit Cost}_i =$											\$0.00
<small>i = 4A to 4NB</small>											

* All losses shall be accounted for, including losses due to any accessory or option. Such as secondary breakers or "MagneX"™ switches etc.
 ** Pro-forma only. All bids are subject to evaluation by total cost of ownership in accordance with loss evaluation formula provided and quoted terms and conditions

3. Pricing and Delivery Terms:

4. **Option Year** Pricing and Delivery Terms:

Bidder: 0 _____
 Contact Person: 0 _____
 Telephone: - _____
 Manufacturer: 0 _____

GROUP A
Type II Dielectric Coolant

Proposal 5

1. Are quoted transformer unit prices firm and not subject to escalation charges?

Check - YES _____ or NO _____

Refer to Technical Specification - Section 1.15

2. If unit prices are subject to escalation, the table below must be filled out completely.

			Please make to 2 decimal places	Please make to 2 decimal places	Please make to 4 decimal places
Commodity Index	Base Reference Index Cost/Value	Current Commodity (Bid Basis)	% Change from Base Index (###.##)	Weighting Factor (Material Cost as a % of Price) (###.##)	Weighted % Change (##.####)
Carbon Steel					
Core Steel					
Copper					
Aluminum					
Mineral Oil (dielectric fluid)					
All other materials, labor, transportation, overhead, and margin			0.00		
Transformer Surcharge Index				0.00%	0.0000

The sum of the above 6 numbers = 100.00%

3. Each bidder shall provide the commodity index and description.

Commodity Index	Description
Carbon Steel	
Core Steel	
Copper	
Aluminum	
Mineral Oil (dielectric fluid)	

4. The Bidder has read section I, paragraph N, entitled "Proposals".

Check - YES _____ or NO _____

5. The Bidder has read and understands section I, paragraph P, entitled "Pricing Terms & Conditions".

Check - YES _____ or NO _____

6. The Bidder has read section I, paragraph R, which relate to "Exceptions to Bid Specifications".

Check - YES _____ or NO _____

GROUP A
Type II Dielectric Coolant

7. The Bidder has read section I, paragraph S, entitled "Contract Period".
Check - YES _____ or NO _____

8. Delivery Terms for first year:

9. **Option Year** Pricing and Delivery Terms:

Bidder: 0 _____
Contact Person: 0 _____
Telephone: - _____
Manufacturer: 0 _____

STATEMENT OF OWNERSHIP DISCLOSURE

N.J.S.A. 52:25-24.2 (P.L. 1977, c.33, as amended by P.L. 2016, c.43)

This statement shall be completed, certified to, and included with all bid and proposal submissions. Failure to submit the required information is cause for automatic rejection of the bid or proposal.

Name of Organization: _____

Organization Address: _____

Part I

Check the box that represents the type of business organization:

- Sole Proprietorship (skip Parts II and III, execute certification in Part IV)
- Non-Profit Corporation (skip Parts II and III, execute certification in Part IV)
- For-Profit Corporation (any type)
- Limited Liability Company (LLC)
- Partnership
- Limited Partnership
- Limited Liability Partnership (LLP)
- Other (be specific): _____

Part II

The list below contains the names and addresses of all stockholders in the corporation who own 10 percent or more of its stock, of any class, or of all individual partners in the partnership who own a 10 percent or greater interest therein, or of all members in the limited liability company who own a 10 percent or greater interest therein, as the case may be. **(COMPLETE THE LIST BELOW IN THIS SECTION)**

OR

No one stockholder in the corporation owns 10 percent or more of its stock, of any class, or no individual partner in the partnership owns a 10 percent or greater interest therein, or no member in the limited liability company owns a 10 percent or greater interest therein, as the case may be. **(SKIP TO PART IV)**

(Please attach additional sheets if more space is needed):

Name of Individual or Business Entity	Address

Part III

DISCLOSURE OF 10% OR GREATER OWNERSHIP IN THE STOCKHOLDERS, PARTNERS OR LLC MEMBERS LISTED IN PART II

If a bidder has a direct or indirect parent entity which is publicly traded, and any person holds a 10 percent or greater beneficial interest in the publicly traded parent entity as of the last annual federal Security and Exchange Commission (SEC) or foreign equivalent filing, ownership disclosure can be met by providing links to the website(s) containing the last annual filing(s) with the federal Securities and Exchange Commission (or foreign equivalent) that contain the name and address of each person holding a 10% or greater beneficial interest in the publicly traded parent entity, along with the relevant page numbers of the filing(s) that contain the information on each such person. **Attach additional sheets if more space is needed.**

Website (URL) containing the last annual SEC (or foreign equivalent) filing	Page #'s

Please list the names and addresses of each stockholder, partner or member owning a 10 percent or greater interest in any corresponding corporation, partnership and/or limited liability company (LLC) listed in Part II **other than for any publicly traded parent entities referenced above.** The disclosure shall be continued until names and addresses of every noncorporate stockholder, and individual partner, and member exceeding the 10 percent ownership criteria established pursuant to N.J.S.A. 52:25-24.2 has been listed. **Attach additional sheets if more space is needed.**

Stockholder/Partner/Member and Corresponding Entity Listed in Part II	Address

**Part IV
Certification**

I, being duly sworn upon my oath, hereby represent that the foregoing information and any attachments thereto to the best of my knowledge are true and complete. I acknowledge: that I am authorized to execute this certification on behalf of the bidder/proposer; that the _____ is relying on the information contained herein and that I am under a continuing obligation from the date of this certification through the completion of any contracts with _____ to notify the _____ in writing of any changes to the information contained herein; that I am aware that it is a criminal offense to make a false statement or misrepresentation in this certification, and if I do so, I am subject to criminal prosecution under the law and that it will constitute a material breach of my agreement(s) with the, permitting the _____ to declare any contract(s) resulting from this certification void and unenforceable.

Full Name (Print):		Title:	
Signature:		Date:	

**AFFIRMATIVE ACTION COMPLIANCE NOTICE
N.J.S.A. 10:5-31 and N.J.A.C. 17:27**

**GOODS AND SERVICES CONTRACTS
(INCLUDING PROFESSIONAL SERVICES)**

This form is a summary of the successful bidder's requirement to comply with the requirements of N.J.S.A. 10:5-31 and N.J.A.C. 17:27-1 et seq.

The successful bidder shall submit to the public agency, after notification of award but prior to execution of this contract, one of the following three documents as forms of evidence:

(a) A photocopy of a valid letter that the contractor is operating under an existing Federally approved or sanctioned affirmative action program (good for one year from the date of the letter);

OR

(b) A photocopy of a Certificate of Employee Information Report approval, issued in accordance with N.J.A.C. 17:27-4;

OR

(c) A photocopy of an Employee Information Report (Form AA302) provided by the Division and distributed to the public agency to be completed by the contractor in accordance with N.J.A.C. 17:27-4.

The successful vendor may obtain the Affirmative Action Employee Information Report (AA302) from the contracting unit during normal business hours.

The successful vendor(s) must submit the copies of the AA302 Report to the Division of Contract Compliance and Equal Employment Opportunity in Public Contracts (Division). The Public Agency copy is submitted to the public agency, and the vendor copy is retained by the vendor.

The undersigned vendor certifies that he/she is aware of the commitment to comply with the requirements of N.J.S.A. 10:5-31 and N.J.A.C. 17:27.1 et seq. and agrees to furnish the required forms of evidence.

The undersigned vendor further understands that his/her bid shall be rejected as non-responsive if said contractor fails to comply with the requirements of N.J.S.A. 10:5-31 and N.J.A.C. 17:27-1 et seq.

COMPANY: _____ SIGNATURE: _____

PRINT NAME: _____ TITLE: _____

DATE: _____

**FAILURE BY BIDDER TO COMPLETE AND RETURN THIS NOTICE WITH THEIR BID SUBMISSION
SHALL BE CAUSE FOR THEIR BID TO BE REJECTED AS NON-RESPONSIVE**

**CITY OF VINELAND
ACKNOWLEDGMENT OF RECEIPT OF ADDENDA**

Pursuant to N.J.S.A. 40A:11-23.1a, the undersigned bidder hereby acknowledges receipt of the following notices, revisions, or addenda to the bid advertisement, specifications or bid documents. By indicating date of receipt, bidder acknowledges the submitted bid takes into account the provisions of notice, revision or addendum. Note that the local unit's record of notice to bidders shall take precedence and that failure to include provisions of changes in a bid proposal may be subject for rejection of the bid.

The undersigned Bidder hereby acknowledges receipt of the following Addenda:

Addendum Number	Dated	Acknowledge Receipt (initial)
_____	_____	_____
_____	_____	_____
_____	_____	_____
_____	_____	_____

No addenda were received:

Acknowledged for: _____
(Name of Bidder)

By: _____
(Signature of Authorized Representative)

Name: _____
(Print or Type)

Title: _____

Date: _____



DISCLOSURE OF INVESTMENT ACTIVITIES IN IRAN FORM

STATE OF NEW JERSEY
DEPARTMENT OF THE TREASURY - DIVISION OF PURCHASE AND PROPERTY
33 WEST STATE STREET, P.O. BOX 230 TRENTON, NEW JERSEY 08625-0230

BID SOLICITATION # AND TITLE: _____

VENDOR NAME: _____

Pursuant to N.J.S.A. 52:32-57, et seq. (P.L. 2012, c.25 and P.L. 2021, c.4) any person or entity that submits a bid or proposal or otherwise proposes to enter into or renew a contract must certify that neither the person nor entity, nor any of its parents, subsidiaries, or affiliates, is identified on the New Jersey Department of the Treasury's Chapter 25 List as a person or entity engaged in investment activities in Iran. The Chapter 25 list is found on the Division's website at <https://www.state.nj.us/treasury/purchase/pdf/Chapter25List.pdf>. Vendors/Bidders must review this list prior to completing the below certification. If the Director of the Division of Purchase and Property finds a person or entity to be in violation of the law, s/he shall take action as may be appropriate and provided by law, rule or contract, including but not limited to, imposing sanctions, seeking compliance, recovering damages, declaring the party in default and seeking debarment or suspension of the party.

CHECK THE APPROPRIATE BOX

I certify, pursuant to N.J.S.A. 52:32-57, et seq. (P.L. 2012, c.25 and P.L. 2021, c.4), that neither the Vendor/Bidder listed above nor any of its parents, subsidiaries, or affiliates is listed on the New Jersey Department of the Treasury's Chapter 25 List of entities determined to be engaged in prohibited activities in Iran.

OR

I am unable to certify as above because the Vendor/Bidder and/or one or more of its parents, subsidiaries, or affiliates is listed on the New Jersey Department of the Treasury's Chapter 25 List. I will provide a detailed, accurate and precise description of the activities of the Vendor/Bidder, or one of its parents, subsidiaries or affiliates, has engaged in regarding investment activities in Iran by completing the information requested below.

Entity Engaged in Investment Activities
Relationship to Vendor/ Bidder
Description of Activities

Duration of Engagement
Anticipated Cessation Date

**Attach Additional Sheets If Necessary.*

CERTIFICATION

I, the undersigned, certify that I am authorized to execute this certification on behalf of the Vendor, that the foregoing information and any attachments hereto, to the best of my knowledge are true and complete. I acknowledge that the State of New Jersey is relying on the information contained herein, and that the Vendor is under a continuing obligation from the date of this certification through the completion of any contract(s) with the State to notify the State in writing of any changes to the information contained herein; that I am aware that it is a criminal offense to make a false statement or misrepresentation in this certification. If I do so, I may be subject to criminal prosecution under the law, and it will constitute a material breach of my contract(s) with the State, permitting the State to declare any contract(s) resulting from this certification void and unenforceable.

Signature _____

Date _____

Print Name and Title _____



CERTIFICATION OF NON-INVOLVEMENT IN PROHIBITED ACTIVITIES IN RUSSIA OR BELARUS

Pursuant to N.J.S.A. 52:32-60.1, et seq. ([L. 2022, c. 3](#)) any person or entity (hereinafter "Vendor") that seeks to enter into or renew a contract with a State agency for the provision of goods or services, or the purchase of bonds or other obligations, must complete the certification below indicating whether or not the Vendor is identified on the Office of Foreign Assets Control (OFAC) Specially Designated Nationals and Blocked Persons list, available here: <https://sanctionssearch.ofac.treas.gov/>. If the Department of the Treasury finds that a Vendor has made a certification in violation of the law, it shall take any action as may be appropriate and provided by law, rule or contract, including but not limited to, imposing sanctions, seeking compliance, recovering damages, declaring the party in default and seeking debarment or suspension of the party.

I, the undersigned, certify that I have read the definition of "Vendor" below, and have reviewed the Office of Foreign Assets Control (OFAC) Specially Designated Nationals and Blocked Persons list, and having done so certify:

(Check the Appropriate Box)

A. That the Vendor is not identified on the [OFAC Specially Designated Nationals and Blocked Persons list on account of activity related to Russia and/or Belarus](#).

OR

B. That I am unable to certify as to "A" above, because the Vendor is identified on the [OFAC Specially Designated Nationals and Blocked Persons list on account of activity related to Russia and/or Belarus](#).

OR

C. That I am unable to certify as to "A" above, because the Vendor is identified on the [OFAC Specially Designated Nationals and Blocked Persons list](#). However, the Vendor is engaged in activity related to Russia and/or Belarus consistent with federal law, regulation, license or exemption. A detailed description of how the Vendor's activity related to Russia and/or Belarus is consistent with federal law is set forth below.

(Attach Additional Sheets If Necessary.)

Signature of Vendor's Authorized Representative	Date
Print Name and Title of Vendor's Authorized Representative	Vendor's FEIN
Vendor's Name	Vendor's Phone Number
Vendor's Address (Street Address)	Vendor's Fax Number
Vendor's Address (City/State/Zip Code)	Vendor's Email Address

ⁱ Vendor means: (1) A natural person, corporation, company, limited partnership, limited liability partnership, limited liability company, business association, sole proprietorship, joint venture, partnership, society, trust, or any other nongovernmental entity, organization, or group; (2) Any governmental entity or instrumentality of a government, including a multilateral development institution, as defined in Section 1701(c)(3) of the International Financial Institutions Act, 22 U.S.C. 262r(c)(3); or (3) Any parent, successor, subunit, direct or indirect subsidiary, or any entity under common ownership or control with, any entity described in paragraph (1) or (2).